



Leaders in Water Management Since 1912

# 2012 | AG Price List

- Canal Gates • Slide Gates • Butterfly Valves • Check Valves •



- Riser Valves • Hydrants • Airtent Vacuum Relief Valves • Line Gates •



Waterman Industries  
 PO Box 458  
 Exeter, CA 93221  
 National Toll Free  
 (800) 331-0808  
[www.watermanusa.com](http://www.watermanusa.com)



## Table of Contents

### Section A

#### RISER VALVES

Alfalfa Valves	5-12
Overflow Valves	13-19
Orchard Valves	20
Air Relief & Drain Valve	21

#### HYDRANTS

Universal Hydrants	22-25
Surge Valves	26
Dairy Flush Valves	27

### Section B

#### AIR VENTS, PRESSURE RELIEF VALVES

AV-150	28
AVP-1	28
CR-101 Parts	29
CRP-8	29
CRP-9	30
AA-6, AA-60D	30
AA-96, AA-9	31
AA-6, AA-96, and AA-9 Parts	32

#### FLAP GATES & CHECK VALVES

PF-25	34-35
PC-30	36
CPC-30-B	37-38
D-34 Drain Valve	39
PC-150	39

Butterfly Valve (In Line Wafer) 40

Filters 42

### Section C

#### Line Gates (IN LINE)

HV-30	43
H-30	44-48
HD-30	49

#### SLIDE

C-2	50-51
C-3 Parts	52
C-8	53
C-8 Parts	54
C-9	55-56
AC-9	57-58
C-10	59-63
C-10 Parts	64-66
Pipe Stubs	67
FC-10	68
C-20	69-71
C-20 Parts	72-73
P-30	74
P-30 Parts	75
AC-31	76
F-10	77-78
F-10 Parts	79
AF-41	80
C-7	81

Miscellaneous Items and Merchandise 82-83



## WATERMAN INDUSTRIES TERMS AND CONDITIONS OF SALE

### GENERAL

These terms and conditions may not be altered or the BUYER'S order terminated in any manner, except by a written agreement signed by an authorized representative of Waterman Industries ("SELLER"). BUYER'S failure to specifically dissent to these TERMS AND CONDITIONS at time of purchase, or BUYER'S acceptance of goods covered by this acknowledgement, shall constitute acceptance of these TERMS AND CONDITIONS.

Written quotations shall be void after thirty (30) days, unless otherwise agreed to by SELLER's authorized representative. Verbal quotations shall be void unless confirmed in writing by SELLER. Otherwise, SELLER reserves the right to apply prices in effect on the date of shipment, and to modify or amend the quotation at any time.

### LIMITATION OF LIABILITY

SELLER warrants only that its products shall be of merchantable quality at the time of shipment and free from defects in material, workmanship and fabrication for a period of twelve (12) months from the date of shipment or completion of manufacture if shipment is delayed by BUYER. SELLER's obligations under this LIMITED WARRANTY shall be limited to replacement or repair of the product or part thereof, if deemed defective at SELLER's sole discretion. Liability under this LIMITED WARRANTY shall under no circumstances exceed the purchase price of the product or part sold hereunder. In no event shall this LIMITED WARRANTY be deemed to cover any items or components not manufactured by SELLER, or provided by others. Equipment supplied but not manufactured by SELLER will be subject to the original manufacturer's warranty. This LIMITED WARRANTY applies only if and to the extent the product sold is used in accordance with all instructions as to handling, maintenance, installation, start-up and safety as prescribed by SELLER.

SELLER shall not be responsible for any damage resulting from improper storage or handling following shipment from SELLER's plant. SELLER will not assume responsibility, expense, or liability for repairs and/or charges performed by others unless such repairs are pre-authorized by SELLER in writing.

No exceptions to any of the foregoing provisions are allowed unless authorized in writing and signed by an officer of SELLER. Failure of the BUYER to submit any claim hereunder within twelve (12) months after shipment shall constitute acknowledgement by BUYER that the product is acceptable. SELLER expressly disclaims any and all warranties hereunder if the failure of any product is due to circumstances beyond the control of the SELLER.

THIS WARRANTY IS NOT VALID IF THE PRODUCT IS INSTALLED AND/OR OPERATED BEYOND WATERMAN'S DESIGN CRITERIA AND/OR PRODUCT SPECIFICATIONS, INCLUDING BUT NOT LIMITED TO: IMPROPER INSTALLATION, OVERPRESSURE, CHEMICAL CONCENTRATES, MECHANICAL ABUSE OR FOREIGN MATERIAL WHICH ARE HARMFUL TO THE INDIVIDUAL COMPONENTS. USE OF NON-WATERMAN PARTS OR MODIFICATIONS VOIDS ALL WARRANTIES.

THE FOREGOING LIMITED WARRANTY IS EXCLUSIVE AND IN LIEU OF ALL OTHER EXPRESSED OR IMPLIED WARRANTIES WHATSOEVER, INCLUDING BUT NOT LIMITED TO WARRANTIES OF MERCHANTABILITY AND FITNESS FOR A PURPOSE.

SELLER shall not be liable under any circumstances for any direct, indirect, consequential, contingent or incidental damages whatsoever resulting from the failure or improper functioning of any product sold hereunder.

### REJECTIONS

Claims of incorrect product shipments must be filed with SELLER in writing within ten (10) days from receipt of shipment. At SELLER's sole discretion, SELLER may re-inspect all rejected product before acceptance or denial of any claim. Unless otherwise agreed to in writing by SELLER, all products alleged to be incorrect must be returned to SELLER's plant freight pre-paid by BUYER. Upon SELLER's confirmation of claim BUYER will be reimbursed for freight charges.

NO PRODUCT MAY BE RETURNED WITHOUT A RETURN MATERIALS AUTHORIZATION NUMBER (RMA) FROM SELLER, ISSUED BY AN AUTHORIZED REPRESENTATIVE OF SELLER.

### CANCELLATIONS AND DEFERRED SHIPMENTS

1. Orders cancelled by BUYER will be subject to cancellation charges to be determined by SELLER.
2. Should shipment of an order be delayed beyond the original scheduled shipping date at BUYER's request and/or requirements or due to a lack of shipping instructions, charges will be levied for storage and/or any other expense incurred by the delay. All materials on delayed orders will be held at BUYER's sole risk and expense.
3. SELLER, with BUYER's permission will ship in advance of scheduled shipping date and will not be held liable for any storage costs or other expenses incurred by advance shipment.

### SHIPMENT

All shipments, unless otherwise quoted in writing by SELLER are F.O.B. SELLER pre-pay and add: TITLE AND RISK OF LOSS PASS TO BUYER UPON SHIPMENT.

Delivery to BUYER'S specified destination cannot be guaranteed. All shipping dates are approximate. SELLER shall not be liable for damages attributable to late delivery or loss of use. SELLER will not be responsible for delays or non-performance caused by circumstances beyond the SELLER's control.

Freight shortages and damage claims due to transportation shall be made directly to the transportation provider by the BUYER. Shipments should be carefully examined upon arrival, prior to delivery receipt being signed. If any loss or damage is evident, it should be noted on the delivery receipt. Have the driver initial such exceptions. The contents of all packages should be examined within 48 hours for concealed damage. The BUYER shall contact the carrier to arrange for prompt inspection of any damaged goods, and to file any claim for damaged goods. If replacement for damaged or lost items is needed, the BUYER will give the SELLER a new order marked "replacement for the same". The BUYER shall pay the invoices for such replacement and request a duplicate receipt to be filed with his claim against the carrier. All claims for shortages must be made within 10 days of receipt of shipment. Claims for shortages must identify item, quantity, packing list number, and date of shipment.



**WATERMAN INDUSTRIES**  
**TERMS AND CONDITIONS OF SALE**

**SHIPMENT** *Continued from previous page:*

In the absence of specific shipping instructions, SELLER reserves the right to ship all material, upon completion by any carrier selected by SELLER.

**SALES AND OTHER TAXES**

Prices do not include sales, use, excise or retailers occupation taxes. SELLER will collect sales tax from BUYER as required by applicable laws unless BUYER provides SELLER with the appropriate sales tax exemption certificate.

**CURRENT PRICES**

All of SELLER's products are sold at prices in effect at the time of order acceptance. Prices, discounts, and terms and conditions of sale are subject to change at any time without notice.

**FORCE MAJEURE**

SELLER expressly disclaims any liabilities due to circumstances beyond the control of the SELLER, including but not limited to improper maintenance and/or use, fire, windstorm, flood, Acts of God, government regulations, unavailability of materials, strikes, work stoppages, slowdowns, boycotts, embargoes, riots, civil disturbances or war.

**MINIMUM ORDER**

Minimum order is \$50.00 net plus shipping, handling charges and applicable taxes.

**PRODUCT CHANGES**

SELLER reserves the right to redesign, alter or modify its products without any liability for customer's or any third party's existing inventory that may become obsolete as a result of such changes.

**RETURNS**

The return of current catalog merchandise will be subjected to a minimum 25% restocking charge and must be in saleable condition for credit to be provided. Parts returned that are not in saleable condition will either be subject to an additional rework charge or possible no credit. All authorized return transactions will be credited back to the BUYER's account, cash payments will not be made. All returns must be accompanied by a Waterman approved Return Authorization. Specials, custom fabricated or modified items will not be accepted for return. Items not listed in the current Waterman catalog or items purchased more than 12 (twelve) months prior to the request date will not receive authorization. All returns must be shipped freight prepaid unless otherwise specified on the Return Material Authorization.

**TERMS OF PAYMENT**

Terms of payment shall be as approved by SELLER upon acceptance of order. Normal terms are 30 days net from the date of shipment. Invoices are dated as the date of shipment or, if shipment is delayed by the BUYER, as the date of the completion of manufacture. If credit is extended, BUYER agrees to pay all attorney and collection fees involved in SELLER's expense to collect.









**DISPUTE RESOLUTION**

This agreement shall be interpreted in accordance with the internal laws of the State of California without regard to choice of law rules. If any portion of this agreement is held by a court to be invalid, the remaining provisions shall remain in full force and effect. All disputes regarding the sale of products and this agreement shall be venued in Tulare County, California. In the event of any controversy, claim or dispute regarding this agreement, the prevailing party shall be entitled to recover from the losing party its reasonable costs, expenses and attorneys fees.

Terms of Sale reviewed and accepted by: \_\_\_\_\_ Date: \_\_\_\_\_  
(Signature of Buyer's Representative)

Name: (please type or print) \_\_\_\_\_ Title: \_\_\_\_\_

## RISER VALVES HYDRANTS

		<u>Pages</u>
	Riser valves are designed to stop the flow of water from a pipeline until the flow is desired. Riser Valves come in two styles, Overflow Valves and Alfalfa Valves.	
<b>ALFALFA</b>	Alfalfa Valves are used with Universal Hydrants to direct the flow of water thru a gated pipe system for furrow irrigation.	5 -12
	Overflow Valves, like Alfalfa Valves come with a variety of frame types. The Type 1, Type 2, and YAKIMA frames are for use with concrete pipe. The YAK frame can be used with a REDI-SET RING.	13-20
<b>YAKIMA</b>		
	All Waterman products termed TYPE 4 or TYPE 4 FRAME are designed for use with PIP (plastic irrigation pipe) rated at 63 PSI. Other sizes can be quoted upon request. <u>The Type 4 frame is inserted into the ID of the pipe and glued using a two part epoxy.</u> This is the typical installation for all type 4 valves.	13-19
<b>TYPE 4</b>		
	For higher head PVC pipe use the CIP IPS/PIP frame. The CIP 'Cast Iron Plastic' frame is designed to fit over the OD of the pipe and is glued using PVC cement.	19-20
<b>CIP/IPS</b>	The CIP valve comes standard for IPS 'Iron Pipe Size' PVC pipe and an insert bushing is glued into the frame for use with PIP 'Plastic Irrigation Pipe'. <u>CIP Cements over the OD of the plastic pipe.</u>	
	The CIP frame is available on Waterman gates and valves sizes 4" to 12".	20
<b>CIP/PIP</b>		
	Universal Hydrants attach to the Alfalfa Valve. If you are not using gated pipe you do not need a Universal Hydrant or Alfalfa Valve	22-25
<b>HYDRANT</b>		
	The Waterman HP-500 Surge Valve is an automated valve designed to conserve water and improve distribution of the water throughout the field, improving production.	26
<b>HP-500</b>		
	The Waterman DF Valve provides a large volume, low head, flush type hydrant designed for quick flush of dairy alleys and slabs. Dairy Flush Valves can be automated using electric motors or pneumatic operators.	22
<b>DAIRY FLUSH</b>		



**RED TOP® & SUNSHINE  
ALFALFA VALVE  
WITH SOLID ARCH**

SIZE	TYPE 1* Special Order (For Concrete Pipe)	TYPE 4 (Spigot for PIP PVC Pipe)	TYPE CIP [1] (Plastic Skirt for PVC Pipe)
6"	N/A	132.00	156.00
Weight		16 lbs.	19 lbs.
Red Top-Vee		N/A	N/A
Red Top-Acme		N/A	N/A
Sunshine-Acme		02406014	02406063
8"	Call	160.00	180.00
Weight	22 lbs.	24 lbs.	26 lbs.
Red Top-Vee	02008001*	02008004*	N/A
Red Top-Acme	N/A	02008014	N/A
Sunshine-Acme	N/A	702408014	02408063
10"	Call	171.00	218.00
Weight	22 lbs.	28 lbs.	39 lbs.
Red Top-Vee	N/A	N/A	N/A
Red Top-Acme	02010010	02010014	N/A
Sunshine-Acme	N/A	02410014	02410063
12"	N/A	208.00	246.00
Weight	30 lbs.	39 lbs.	49 lbs.
Red Top-Vee	N/A	N/A	N/A
Red Top-Acme	N/A	02012014	N/A
Sunshine-Acme	N/A	02412014	02412063

Note: Part #'s shown is for PIP size pipe. For IPS size pipe, replace last digit of Part # with a "1".

Note that CIP and PIP are the same price.

Type 4 is designed for PIP 63. Other sizes can be quoted upon request, please specify size required.

\*Special Order Item. Call factory for price and lead time.



PARTS FOR  
**RED TOP**® ALFALFA VALVE  
 WITH SOLID ARCH

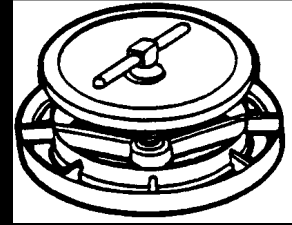

PART	8"	10"	12"
<b>FRAME:</b>			
TYPE 1 - VEE	Special Order 40008007	Special Order 40010007	N/A
TYPE 1 - ACME	Special Order 40008017	Special Order 40010017	N/A
TYPE 4 - VEE	98.00 40008008	122.00 40010008	151.00 40012008
TYPE 4 - ACME	98.00 40008018	122.00 40010018	151.00 40012018
<b>PACKED COVER:</b>	44.00 41208011	56.00 41210011	67.00 41212011
<b>PACKING GASKET:</b>	7.00 43508002	7.00 43510001	8.00 43512001
<b>BRONZE SCREW:</b>			
VEE THREAD	52.00 42508004	63.00 42510005	67.00 42512004
ACME THREAD	52.00 42508014	63.00 42510014	67.00 42512014
<b>WASHER</b>	4.00 81808010	4.00 81810010	4.00 81811010
<b>SCREW COMPLETE:</b>			
VEE THREAD	59.00 43008004	72.00 43010005	76.00 43012004
ACME THREAD	59.00 43008014	72.00 43010014	76.00 43012014
<b>COVER COMPLETE:</b>			
VEE THREAD	95.00 41508011	118.00 41510011	134.00 41512011
ACME THREAD	95.00 41508021	118.00 41510021	134.00 41512021
<b>BRASS NUT:</b>			
VEE THREAD	5.00 80208009	6.00 80208002	6.00 80209001
ACME THREAD	5.00 80208010	6.00 80208012	6.00 80209010

For Special Order Items call factory for price and lead time.



PARTS FOR  
**SUNSHINE ALFALFA VALVE  
 WITH SOLID ARCH**

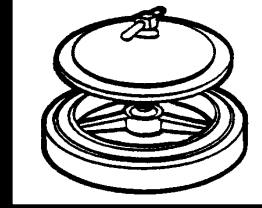

PART	6"	8"	10"	12"
<b>FRAMES:</b>				
<b>TYPE 4-ACME</b>	84.00	102.00	129.00	157.00
	40006034	40008034	40010034	40012034
<b>TYPE CIP/PIP-ACME</b>	109.00	140.00	168.00	200.00
	40306059	40308060	40310060	40312060
<b>TYPE CIP/IPS-ACME</b>	109.00	140.00	168.00	200.00
	40306061	40308058	40310058	40312058
<b>PACKED</b>	32.00	44.00	55.00	66.00
<b>COVER</b>	41206014	41208022	41210022	41212002
<b>PACKING</b>	6.00	7.00	7.00	8.00
<b>GASKET</b>	43506002	43508002	43510001	43512001
<b>BRONZE SCREW</b>	52.00	52.00	63.00	67.00
<b>ACME</b>	42508014	42508014	42510014	42512014
<b>BRASS NUT</b>	5.00	5.00	6.00	6.00
<b>ACME THREAD</b>	80208010	80208010	80208012	80209010
<b>UHMW</b>	4.00	4.00	4.00	4.00
<b>WASHER</b>	81808010	81808010	81810010	81811010
<b>SCREW COMPLETE</b>	59.00	59.00	72.00	76.00
<b>ACME THREAD</b>	43008014	43008014	43010014	43012014
<b>COVER COMPLETE</b>	91.00	95.00	118.00	134.00
<b>ACME</b>	41506014	41508022	41510020	41512012



RED TOP ® & SUNSHINE  
**ALFALFA VALVE**  
 WITH REMOVABLE ARCH



SIZE	TYPE 1 (For Concrete Pipe)	TYPE 4 (Spigot for PVC Pipe)	TYPE CIP [1] (Plastic Skirt for PVC Pipe)
<b>8"</b>	<b>153.00</b>	<b>177.00</b>	<b>220.00</b>
Weight	18 lbs	29 lbs	29 lbs
Red Top-Vee	02208001	N/A	N/A
Red Top-Acme	02208010	02208040	02208073
Sunshine-Acme	N/A	N/A	N/A
<b>10"</b>	<b>154.00</b>	<b>215.00</b>	<b>266.00</b>
Weight	25 lbs	48 lbs	40 lbs
Red Top-Vee	N/A	N/A	N/A
Red Top-Acme	02210010	02210040	02210073
Sunshine-Acme	02610010 Special Order	02610040	02610063 Special Order
<b>12"</b>	<b>195.00</b>	<b>249.00</b>	<b>315.00</b>
Weight	34 lbs	58 lbs	55 lbs
Red Top-Vee	02212001 Special Order	02212004 Special Order	N/A
Red Top-Acme	02212010	02212040	02212073
Sunshine-Acme	02612010 Special Order	02612040	02612063
<b>14"</b>	<b>321.00</b>	<b>N/A</b>	<b>N/A</b>
Weight	49 lbs		
Red Top-Vee	02214001 Special Order		
Red Top-Acme	02214010		
Sunshine-Acme	02614010 Special Order		
<b>15" X 14"</b> (for 15" Pipe)	<b>N/A</b>	<b>362.00</b>	<b>N/A</b>
Weight		78 lbs.	
Red Top-Vee		N/A	
Red Top-Acme		02215154	
Sunshine-Acme		02615154	

[1] Part # shown is for PIP size pipe. For IPS size pipe, replace last digit of Part # with a "1".

It is up to the customer to check PVC pipe availability of Low Head PIP before ordering "TYPE 4" configuration.

Type 4 is designed for PIP 63. Other sizes can be quoted upon request, please specify size required.

For Special Order Items call factory for price and lead time.



RED TOP ® & SUNSHINE  
**ALFALFA VALVE**  
 WITH REMOVABLE ARCH





SIZE	TYPE 1* (For Concrete Pipe)	TYPE 4* (Spigot for PVC Pipe)	TYPE CIP (Plastic Skirt for PVC Pipe)
16"	Special Order	N/A	N/A
Weight	53 lbs		
Red Top-Vee	02216001		
Red Top-Acme	02216010		
Sunshine-Acme	02616010		
18"	Special Order	Special Order	N/A
Weight	74 lbs	101 lbs	
Red Top-Vee	02218001	N/A	
Red Top-Acme	02218010	02218040	
Sunshine-Acme	N/A	02618040	
20"	Special Order	Special Order	N/A
Weight	91 lbs	111 lbs	
Red Top-Vee	N/A	N/A	
Red Top-Acme	02220010	02220040	
Sunshine-Acme	N/A	02620040	
24"	Special Order	Special Order	N/A
Weight	135 lbs	149 lbs.	
Red Top-Vee	N/A	N/A	
Red Top-Acme	02224010	02224040	
Sunshine-Acme	N/A	N/A	
30"	Special Order	N/A	N/A
Weight	245 lbs		
Red Top-Vee	N/A		
Red Top-Acme	02230010		
Sunshine-Acme	N/A		
36"	Special Order	N/A	N/A
Weight	530 lbs		
Red Top-Vee	N/A		
Red Top-Acme	02236010		
Sunshine-Acme	N/A		
<b>Replacement "Tee HANDLE BARS" (Stainless Steel) for ALFALFA VALVES:</b>			
Valve Size	6" - 8"	10" - 12"	14" - 24"
Bar Size	½" x 6"	½" x 7"	½" x 8"
Price	10.00	11.00	12.00
	50005006	50005007	50005008

It is up to the customer to check PVC pipe availability of Low Head PIP before ordering "TYPE 4" configuration

Type 4 is designed for PIP 63. Other sizes can be quoted upon request, please specify size required.

For Special Order Items call factory for price and lead time.

		PARTS FOR RED TOP @ALFALFA VALVE WITH REMOVABLE ARCH				
PART	8"	10"	12"	14"	15" X 14"	
<b>FRAMES:</b>						
TYPE 1	95.00	116.00	147.00	155.00		
	40008051	40010051	40012051	40014051		
TYPE 4	95.00	116.00	147.00		184.00	
	40008054	40010054	40012054		40015154	
TYPE CIP-PIP	116.00	136.00	166.00			
	40208071	40210071	40212071			
TYPE CIP-IPS	116.00	136.00	166.00			
	40208070	40210070	40212070			
<b>ARCH:</b>						
VEE	36.00	37.00	45.00	55.00	55.00	
THREAD	44208001	44208120	44210120	44214001	44214001	
ACME	36.00	37.00	45.00	55.00	55.00	
THREAD	44208010	44208121	44210121	44214010	44214010	
<b>PACKED COVER:</b>	44.00	56.00	67.00	117.00	117.00	
	41208011	41210011	41212011	41214011	41214011	
<b>PACKING GASKET:</b>	7.00	7.00	8.00	12.00	12.00	
	43508002	43510001	43512001	43514001	43514001	
<b>BRONZE SCREW:</b>						
VEE	52.00	63.00	67.00	86.00	86.00	
THREAD	42508004	42510005	42512004	42516005	42516005	
ACME	52.00	63.00	67.00	86.00	86.00	
THREAD	42508014	42510014	42512014	42516015	42516015	
<b>BRASS NUT:</b>						
VEE	5.00	6.00	6.00	6.00	6.00	
THREAD	80208000	80208002	80209001	80210001	80210001	
ACME	5.00	6.00	6.00	6.00	6.00	
THREAD	80208010	80208012	80208012	80210010	80210010	
<b>UHMW WASHER</b>	4.00	4.00	4.00	4.00	4.00	
	81808010	81810010	81811010	81812010	81812010	
<b>SCREW COMPLETE:</b>						
VEE	59.00	72.00	76.00	93.00	93.00	
THREAD	43008004	43010005	43012004	43016005	43016005	
ACME	59.00	72.00	76.00	93.00	93.00	
THREAD	43008014	43010014	43012014	43016015	43016015	
<b>COVER COMPLETE:</b>						
VEE	95.00	118.00	134.00	196.00	196.00	
THREAD	41508011	41510011	41512011	41514011	41514011	
ACME	95.00	118.00	134.00	196.00	196.00	
THREAD	41508021	41510021	41512021	41514021	41514021	
<b>ECCENTRIC</b>	9.00	9.00	9.00	9.00	9.00	
<b>LATCH</b>	101589	101589	101589	101589	101589	
<b>RIVET</b>	3.00	3.00	3.00	3.00	3.00	
	1254	1254	1258	1258	1258	

		PARTS FOR RED TOP ®ALFALFA VALVE WITH REMOVABLE ARCH					
(Special Order Parts on 16" to 36")							
PART	16"	18"	20"	24"	30"	36"	
<b>FRAMES:</b>							
TYPE 1	40016051	40018051	40020051	40024051	40030051	40036051	
TYPE 4		40018054	40020054				
<b>ARCH:</b>							
VEE THREAD	44216001	44218001	44220001	44224001			
ACME THREAD	44216010	44218010	44220010	44224010	44230010	44236010	
<b>PACKED COVER:</b>							
	41216011	41218011	41220011	41224011	41230011	41236011	
<b>PACKING GASKET:</b>							
	43516001	43518001	43520001	43524002	43530002	43536002	
<b>BRONZE SCREW:</b>							
VEE THREAD	42516005	42520004	42520004	42520006			
ACME THREAD	42516015	42520014	42520014	42520012			
<b>BRASS NUT:</b>							
VEE THREAD	80210001	80210001	80210001	80210001			
ACME THREAD	80210010	80210010	80210010	80210010	1015868	1015868	
<b>UHMW WASHER</b>							
	81812010	81812010	81812010	81812010	81820001	81820001	
<b>SCREW COMPLETE:</b>							
VEE THREAD	43016005	43020004	43020004	43020006			
ACME THREAD	43016015	43020014	43020014	43020012	43030014	43036014	
<b>COVER COMPLETE:</b>							
VEE THREAD	41516011	41518011	41520011	41524011			
ACME THREAD	41516021	41518021	41520021	41524021	41530021	41536021	

For Special Order Items call factory for price and lead time.



PARTS FOR  
SUNSHINE ALFALFA VALVE  
WITH REMOVABLE ARCH



PART	8"	8" X 10"	10"	10" X 12"	12"	14"	15" X 14"	16"	18"	20"
<b>FRAMES:</b>										
TYPE 1	95.00	NA	116.00	NA	147.00	155.00		Call	Call	
	40008051		40010051		40012051	40014051		40016051	40018051	
TYPE 4	95.00	NA	116.00	NA	147.00		184.00		Call	Call
	40008054		40010054		40012054		40015154		40018054	40020054
TYPE CIP-PIP	116.00	NA	136.00	NA	166.00					
	40208071		40210071		40212071					
TYPE CIP-IPS	116.00	NA	136.00	NA	166.00					
	40208070		40210070		40212070					
<b>ARCH:</b>										
ACME	36.00	NA	37.00	NA	45.00	55.00	55.00	Call	Call	Call
THREAD	44208002		44210002		44212002	44214002	44214002	44216010	44218010	44220010
PACKED	44.00	NA	55.00	NA	66.00	116.00	116.00	Call	Call	Call
COVER	41208022		41210022		41212002	41214002	41214002	41216002	41218002	41220002
PACKING	7.00	NA	7.00	NA	8.00	12.00	12.00	Call	Call	Call
GASKET	43508002		43510001		43512001	43514001	43514001	43516001	43518001	43520001
<b>BRASS SCREW:</b>										
ACME	52.00	NA	63.00	NA	67.00	86.00	86.00	Call	Call	Call
THREAD	42508014		42510014		42512014	42514012	42514012	42520014	42520012	42520012
<b>BRASS NUT:</b>										
ACME	5.00	NA	6.00	NA	6.00	6.00	6.00	Call	Call	Call
THREAD	80208010		80208012		80209010	80209010	80209010	80210010	80210010	80210010
UHMW WASHER	4.00	NA	4.00	NA	4.00	4.00	4.00	Call	Call	Call
	81808010		81810010		81811010	81811010	81811010	81812010	81812010	81812010
<b>SCREW COMPLETE:</b>										
ACME	59.00	NA	72.00	NA	76.00	93.00	93.00	Call	Call	Call
THREAD	43008014		43010014		43012014	43014012	43014012	43020014	43020012	43020012
<b>COVER COMPLETE:</b>										
ACME	95.00	NA	118.00	NA	134.00	195.00	195.00	Call	Call	Call
THREAD	41508022		41510020		41512012	41514015	41514015	41516012	41518012	41520012
ECCENTRIC	9.00	NA	9.00	NA	9.00	9.00	9.00	Call	Call	Call
LATCH	101589		101589		101589	101589	101589	101589	101589	101589
RIVET	3.00	NA	3.00	NA	3.00	3.00	3.00	Call	Call	Call
	1254		1254		1258	1258	1258	1258	1257	1257

For Special Order Items call factory for price and lead time.



RED TOP®  
**OVERFLOW VALVE**  
**SOLID ARCH**  
 WITH YAKIMA FRAME  
 FOR CONCRETE PIPE  
 WITH BRONZE SCREW



SIZE	WEIGHT (LBS)	PRICE WITH VEE THREAD	PRICE WITH ACME THREAD
3 1/2"	3	53.00 01203001	
4"	3 1/2	53.00 01204001	
5"	4	57.00 01205001	
6"	6 1/2	59.00 01206001	59.00 01206010
6 1/2"	7 1/2	79.00 01207001	NA
8"	10	79.00 01208001	79.00 01208010
10"	15	112.00 01210001	112.00 01210010
12"	21	135.00 01212001	135.00 01212010
14"	28	181.00 01214001	181.00 01214010
16"	40	N/A	Special Order 01216010
18"	50	N/A	Special Order 01218010
20"	63	N/A	Special Order 01220010
<b>REDI-SET RINGS ONLY</b>			
<b>STANDARD SIZES</b>			
3 1/2" X 8"		8.00 95003008	
4" X 8"		8.00 95004008	
5" X 8"		8.00 95005008	
8" X 12"		9.00 95008012	
10" X 14"		13.00 95010014	

For Special Order Items call factory for price and lead time.



RED TOP®  
**OVERFLOW VALVE  
 SOLID ARCH**  
 WITH TYPE 4 FRAME  
 FOR PIP PLASTIC PIPE  
 WITH BRONZE SCREW

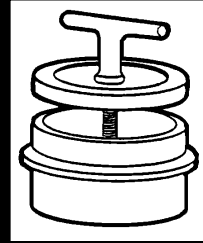

SIZE	WEIGHT (LBS.)	PIPE SIZE	PRICE WITH VEE THREAD	PRICE WITH ACME THREAD
4"	3½"	4"	47.00 01204002	
5" x 6"	4	6"	55.00 01205002	
6"	7	6"	67.00 01206002	67.00 01206020
8"	10	8"	78.00 01208002	78.00 01208020
10"	15	10"	112.00 01210002	112.00 01210020
12"	21	12"	164.00 01212002	164.00 01212020
15" x 14"	45	15"		201.00 01214154
18"	50	18"		441.00 01218020
20"	63	20"		527.00 01220020

Type 4 is designed for PIP 63. Other sizes can be quoted upon request, please specify size required.



PARTS FOR  
RED TOP® OVERFLOW VALVE

SIZE	YAKIMA FRAME VEE	YAKIMA FRAME ACME	TYPE 4 FRAME VEE	TYPE 4 FRAME ACME	PACKED COVER	PACKING GASKET	BRASS SCREW VEE	BRASS SCREW ACME
3"						4.00 43502001	17.00 42505001	
3½"	17.00 40003003				19.00 41203001	4.00 43503001	17.00 42505001	
4"	18.00 40004003		19.00 40004004		19.00 41204001	4.00 43504001	17.00 42505001	
5"	36.00 40005003		31.00 40005004		20.00 41205001	5.00 43505001	21.00 42505002	
6"	36.00 40006003	36.00 40006013	33.00 40006004	36.00 40006014	25.00 41206001	5.00 43506001	28.00 42506001	28.00 42506010
6½"	36.00 40007003	36.00 40007013			26.00 41207001	5.00 43507001	28.00 42506001	28.00 42506010
8"	38.00 40008003	38.00 40008013	45.00 40008004	45.00 40008014	35.00 41208001	7.00 43508001	28.00 42506001	28.00 42506010
10"	46.00 40010003	46.00 40010013	54.00 40010004	54.00 40010014	46.00 41210001	7.00 43510001	50.00 42510001	50.00 42510010
12"	52.00 40012003	52.00 40012013	81.00 40012004	81.00 40012014	55.00 41212001	8.00 43512001	50.00 42510001	50.00 42510010
14"	79.00 40014003	79.00 40014013			99.00 41214001	12.00 43514001	62.00 42514001	62.00 42514010
15" X 14"			137.00 40014152	137.00 40014154	99.00 41214001	12.00 43514001	62.00 42514001	62.00 42514010
16"	Call 40016003	Call 40016013			Call 41216011	Call 43516001	Call 42516005	Call 42516015
18"	Call 40018003	Call 40018013	Call 40018004	Call 40018014	Call 41218011	Call 43518001	Call 42520004	Call 42520014
20"	Call 40020003	Call 40020013	Call 40020004	Call 40020014	Call 41220011	Call 43520001	Call 42520004	Call 42520014
<b>PARTS CONTINUED</b>								
SIZE	BRASS NUT-VEE	BRASS NUT-ACME	UHMW WASHER	SCREW COMP-VEE	SCREW COMP-ACME	COVER COMP-VEE	COVER COMP-ACME	
3"	4.00 80205001		3.00 81805001	21.00 43005001				
3½"	4.00 80205001		3.00 81805001	21.00 43005001		40.00 41503001		
4"	4.00 80205001		3.00 81805001	21.00 43005001		42.00 41504001		
5"	4.00 80205001		3.00 81805001	25.00 43005002		53.00 41505001		
6"	4.00 80206001	4.00 80206010	3.00 81806001	32.00 43006001	32.00 43006010	65.00 41506001	65.00 41506010	
6½"	4.00 80206001	4.00 80206010	3.00 81806001	32.00 43006001	32.00 43006010	66.00 41507001	66.00 41507010	
8"	4.00 80206001	4.00 80206010	3.00 81806001	32.00 43006001	32.00 43006010	72.00 41508001	72.00 41508010	
10"	5.00 80207001	5.00 80207010	3.00 81807001	56.00 43010001	56.00 43010010	100.00 41510001	100.00 41510010	
12"	5.00 80207001	5.00 80207010	3.00 81807001	56.00 43010001	56.00 43010010	156.00 41512001	156.00 41512010	
14"	5.00 80208009	5.00 80208011	4.00 81808010	69.00 43014001	69.00 43014010	165.00 41514001	165.00 41514010	
15" X 14"	5.00 80208009	5.00 80208011	4.00 81808010	69.00 43014001	69.00 43014010	165.00 41514001	165.00 41514010	
16"	Call 80210001	Call 80210010	Call 81812010	Call 43016005	Call 43016015	Call 41516011	Call 41516021	
18"	Call 80210001	Call 80210010	Call 81812010	Call 43020004	Call 43020014	Call 41518011	Call 41518021	
20"	Call 80210001	Call 80210010	Call 81812010	Call 43020004	Call 43020014	Call 41520011	Call 41520021	

For Special Order Items call factory for price and lead time.

TOLL FREE (800) 331-0808  
www.watermanusa.com



**RED TOP® OVERFLOW VALVE  
SOLID ARCH  
WITH CIP FRAME**

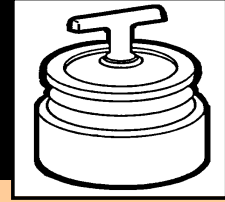

SIZE	WEIGHT (lbs.)	IPS WITH BRONZE SCREW	PIP WITH BRONZE SCREW
4" VEE	3	81.00 01204006	
6" X 5" VEE	7	90.00 01205051	90.00 01205053
6" ACME	7.5	90.00 01206051	90.00 01206053
8" ACME	12.5	112.00 01208051	112.00 01208053
10" ACME	20	157.00 01210051	157.00 01210053
12" ACME	27	181.00 01212051	181.00 01212053

**PARTS FOR RED TOP® OVERFLOW VALVES**

SIZE	FRAME WITH IPS INSERT	FRAME WITH PIP INSERT	PACKED COVER	PACKING GASKET	BRONZE SCREW	BRASS NUT	WASHER	PIP * INSERT
4"	53.00 40304002	N/A	19.00 41204001	4.00 43504001	17.00 42505001	4.00 80205001	3.00 81805001	
6" x 5"	58.00 40305001	60.00 40305002	20.00 41205001	5.00 43505001	21.00 42505002	4.00 80205001	3.00 81805001	15.00 1800418
6"	58.00 40306001	60.00 40306002	25.00 41206001	5.00 43506001	28.00 42506010	4.00 80206010	3.00 81805001	15.00 1800418
8"	59.00 40308001	65.00 40308002	35.00 41208001	7.00 43508001	28.00 42506010	4.00 80206010	3.00 81806001	15.00 1800408
10"	112.00 40310001	117.00 40310002	46.00 41210001	7.00 43510001	50.00 42510010	5.00 80207010	3.00 81807001	19.00 1800412
12"	126.00 40312001	129.00 40312002	55.00 41212001	8.00 43512001	50.00 42510010	5.00 80207010	3.00 81807001	19.00 1800409

\* PIP - INSERT ONLY - USE TO ADAPT IPS TO PIP AND INCLUDES FRAME. SEE "FRAME W/IPS INSERT" IN LEFT COLUMN.

CIP includes a plastic PVC skirt that fits over the PVC pipe.

Specify what type of pipe when ordering.



**SUNSHINE OVERFLOW VALVE  
SOLID ARCH  
WITH CIP FRAME**

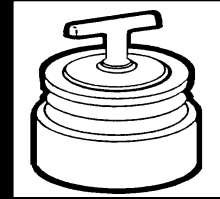

SIZE	WEIGHT (lbs.)	IPS W/BRONZE SCREW	PIP W/BRONZE SCREW
4"	3.5	N/A 01404006	N/A
6" X 5"	7	95.00 01405051	95.00 01405053
6"	7.5	100.00 01406051	100.00 01406053
8"	12	112.00 01408051	112.00 01408053

SIZE	FRAME WITH IPS INSERT	FRAME WITH PIP INSERT	PACKED COVER	PACKING GASKET	BRONZE SCREW	BRASS NUT	UHMW WASHER
4"	53.00 40304002	N/A	13.00 41204002	4.00 43504001	17.00 42505001	4.00 80205001	3.00 81805001
6" x 5"	58.00 40305001	60.00 40305002	17.00 41205002	5.00 43505001	21.00 42505002	4.00 80205001	3.00 81805001
6"	58.00 40306001	60.00 40306002	19.00 41206002	5.00 43506001	28.00 42506010	4.00 80206010	3.00 81805001
8"	59.00 40308001	65.00 40308002	27.00 41208002	7.00 43508001	28.00 42506010	4.00 80206010	3.00 81806001

NOTE: PURCHASE 3 VALVES AND GET A STANDARD KEY AT NO CHARGE.

**PASTURE OVERFLOW VALVE  
SOLID ARCH  
WITH CIP FRAME**

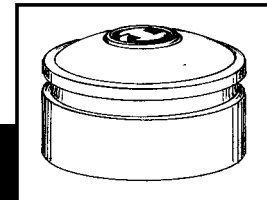

SIZE	WEIGHT (lbs.)	IPS W/VEE THREAD	PIP W/VEE THREAD	IPS W/ACME THREAD	PIP W/ACME THREAD
4"	3.5	80.00 01604051	N/A	N/A	N/A
6" x 5"	7	80.00 01605051	80.00 01605053	N/A	N/A
6"	7.5	Special Order 01606050*	103.00 01606052	103.00 01606051	Special Order 01606053*
8"	12.5	133.00 01608050	133.00 01608052	133.00 01608051	Special Order 01608053*
10"	20	178.00 01610050	178.00 01610052	N/A 01610051	N/A 01610053
12"	27	Special Order 01612050*	Special Order 01612052*	191.00 01612051	Special Order 01612053*

Note that PIP Insert is used to adapt CIP TO PIP.

\*Special Order Item. Call factory for price and lead time.



**PASTURE OVERFLOW VALVE  
SOLID ARCH  
WITH YAKIMA FRAME  
FOR CONCRETE PIPE  
WITH BRONZE SCREW**

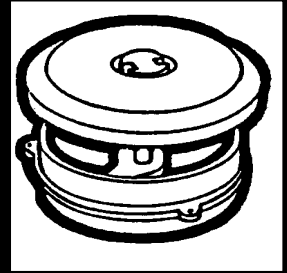

NOTE: PURCHASE 3 VALVES AND GET A STANDARD KEY AT NO CHARGE.

SIZE	WEIGHT (lbs.)	PIPE SIZE	PRICE WITH VEE THREAD	PRICE WITH ACME THREAD
3½"	3.5	3½"	Special Order 01603001	N/A
4"	3	4"	Special Order 01604001*	N/A
5"	5	5"	N/A	N/A
6"	7	6"	N/A	60.00 01606010
8"	11	8"	N/A	Special Order 01608010*
10"	16	10"	N/A	Special Order 01610010*
12"	22	12"	N/A	139.00 01612010

**PASTURE OVERFLOW VALVE  
SOLID ARCH  
WITH TYPE 4 FRAME  
FOR PLASTIC PIPE  
WITH BRONZE SCREW**



NOTE: PURCHASE 3 VALVES AND GET A STANDARD KEY AT NO CHARGE.

SIZE	WEIGHT (lbs.)	PIPE SIZE	PRICE WITH VEE THREAD	PRICE WITH ACME THREAD
4"	3	4"	48.00 01604002	N/A
6"X5"	5	5"	N/A	N/A
6"	7	6"	N/A	77.00 01606020
8"	11	8"	N/A	91.00 01608020
10"	16	10"	N/A	112.00 01610020
12"	22	12"	N/A	163.00 01612020

PASTURE VALVE KEYS:

STANDARD	8.00	42510100
4' SPINNER	18.00	42512100

Type 4 is designed for PIP 63. Other sizes can be quoted upon request, please specify size required.

\*Special Order Item. Call factory for price and lead time.

		PARTS FOR PASTURE OVERFLOW VALVE			
SIZE	YAKIMA FRAME VEE	YAKIMA FRAME ACME	TYPE 4 FRAME VEE	TYPE 4 FRAME ACME	PACKED COVER
3½"	17.00 40003003				25.00 41203003
4"	18.00 40004003		19.00 40004004		25.00 41204003
5"	36.00 40005003		31.00 40005004		25.00 41205003
6"		36.00 40006013		36.00 40006014	29.00 41206003
8"		38.00 40008013		45.00 40008014	38.00 41208003
10"		46.00 40010013		54.00 40010014	53.00 41210003
12"		52.00 40012013		81.00 40012014	63.00 41212003
SIZE	PACKING GASKET	BRONZE SCREW VEE	BRONZE SCREW ACME	BRONZE NUT VEE	BRONZE NUT ACME
3½"	4.00 43503001	20.00 42505003		4.00 80205001	
4"	4.00 43504001	20.00 42505003		4.00 80205001	
5"	5.00 43505001	20.00 42505003		4.00 80205001	
6"	5.00 43506001	32.00 42506003	32.00 42506013	4.00 80206001	4.00 80206010
8"	7.00 43508001	32.00 42506003	32.00 42506013	4.00 80206001	4.00 80206010
10"	7.00 43510001	50.00 42510003	50.00 42510013	5.00 80207001	5.00 80207010
12"	8.00 43512001		50.00 42510013	5.00 80207001	5.00 80207010
SIZE	UHMW WASHER	SCREW COMP. VEE	SCREW COMP. ACME	COVER COMP. VEE	COVER COMP. ACME
3½"	3.00 81805001	29.00 43005003		40.00 41503003	
4"	3.00 81805001	29.00 43005003		49.00 41504003	
5"	3.00 81805001	29.00 43005003		49.00 41505003	
6"	3.00 81806001		36.00 43006013		57.00 41506013
8"	3.00 81806001		36.00 43006013		66.00 41508013
10"	3.00 81807001		56.00 43010013		109.00 41510013
12"	3.00 81807001		56.00 43010013		119.00 41512013

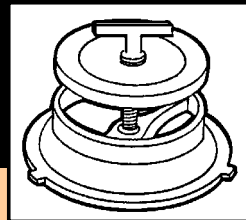
**RED TOP®  
ORCHARD VALVE**

NO.	OPENING SIZE X PIPE SIZE	WT. (lbs.)	PRICE
6	3½" X 6"	3	45.00 00406001
8	5" X 8"	4.5	59.00 00408001
10	6½" X 10"	7.5	72.00 00410001
12	8" X 12"	10	76.00 00412001
14	10" X 14"	16	139.00 00414001
16	12" X 16"	21	216.00 00416001

**PARTS FOR RED TOP® ORCHARD VALVE**

PART	NO. 6	NO. 8	NO. 10	NO. 12	NO. 14	NO. 16
FRAME	27.00 40006001	27.00 40008001	31.00 40010001	32.00 40012001	100.00 40014001	109.00 40016001
PACKED COVER	19.00 41203001	20.00 41205001	26.00 41207001	35.00 41208001	46.00 41210001	55.00 41212001
BRONZE SCREW	17.00 42505001	21.00 42505002	28.00 42506001	28.00 42506001	50.00 42510001	50.00 42510001
BRASS NUT	4.00 80205001	4.00 80205001	4.00 80206001	4.00 80206001	5.00 80207001	5.00 80207001
UHMW WASHER	3.00 81805001	3.00 81805001	3.00 81806001	3.00 81806001	3.00 81807001	3.00 81807001
PACKING GASKET	4.00 43503001	5.00 43505001	5.00 43507001	7.00 43508001	7.00 43510001	8.00 43512001
SCREW COMPLETE	21.00 43005001	25.00 43005002	32.00 43006001	32.00 43006001	56.00 43010001	56.00 43010001
COVER COMPLETE	40.00 41503001	53.00 41505001	66.00 41507001	72.00 41508001	100.00 41510001	156.00 41512001

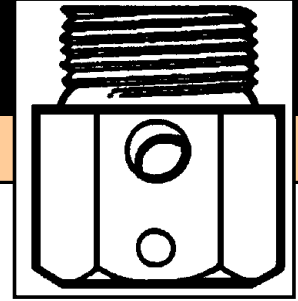
**Waterman**
**AIR RELIEF AND  
DRAIN VALVE**

SIZE (IN.)	WEIGHT (lbs.)	PRICE	
3/8	1/4	28.00 20801001	
PARTS:			
BODY	SEAT RING	FLOAT BALL	PIN
15.00 405-01-208	5.00 43200011	6.00 47001001	4.00 82601007

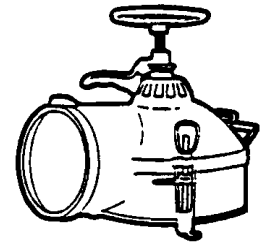
**UNIVERSAL HYDRANT  
WITH GASKETED OUTLET (EXCEPT STUB)**

HYDRANT SIZE Body X Outlet	<u>SINGLE OUTLET</u>		<u>DOUBLE OUTLET</u>		<u>SINGLE COMBINATION</u>	
	WT. (lbs.)	PRICE	WT. (lbs.)	PRICE	WT. (lbs.)	PRICE
6" X Stub		354.00		N/A		N/A
Red Top C. T.	N/A	N/A		-		-
Hook Type	14	03220006		-		-
6" X 4"		401.00		N/A		N/A
Red Top C. T.	N/A	N/A		-		-
Hook Type	15	703210604		-		-
6" X 5"		401.00		N/A		N/A
Red Top C. T.	N/A	N/A		-		-
Hook Type	15	03210605		-		-
6" X 6"		401.00		N/A		N/A
Red Top C. T.	N/A	N/A		-		-
Hook Type	16	03210606		-		-
8" X Stub		459.00		N/A		517.00
Red Top C. T.	19	03320008		-	21	03420008
Hook Type	17	03220008		-	N/A	N/A
8" X 5"		483.00		N/A		517.00
Red Top C. T.	21	03310805		-	23	703410805
Hook Type	19	03210805		-	N/A	N/A
8" X 6"		483.00		N/A		517.00
Red Top C. T.	22	03310806		-	24	703410806
Hook Type	20	03210806		-	N/A	N/A
8" X 7"		483.00		N/A		517.00
Red Top C. T.	22	703310807		-	24	703410807
Hook Type	20	703210807		-	N/A	N/A
8" X 8"		483.00		N/A		517.00
Red Top C. T.	23	03310808		-	25	03410808
Hook Type	21	03210808		-	N/A	N/A
10" X Stub		539.00		N/A		572.00
Red Top C. T.	19	03320010		-	21	703420010
Hook Type	18	03220010		-	N/A	N/A
10" X 5"		564.00		N/A		598.00
Red Top C. T.	22	03311005		-	24	703411005
Hook Type	20	703211005		-	N/A	N/A
10" X 6"		564.00		N/A		598.00
Red Top C. T.	22	03311006		-	25	703411006
Hook Type	20	03211006		-	N/A	N/A
10" X 7"		564.00		N/A		598.00
Red Top C. T.	23	03311007		-	26	703411007
Hook Type	21	703211007		-	N/A	N/A
10" X 8"		564.00		N/A		598.00
Red Top C. T.	24	03311008		-	27	03411008
Hook Type	22	03211008		-	N/A	N/A
10" X 10"		564.00		N/A		598.00
Red Top C. T.	32	03311010		-	39	03411010
Hook Type	30	03211010		-	N/A	N/A



**UNIVERSAL HYDRANT  
WITH GASKETED OUTLET (EXCEPT STUB)  
CONTINUED**

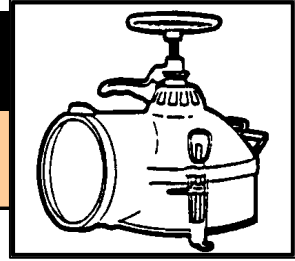

HYDRANT SIZE BODY X OUTLET	SINGLE OUTLET		DOUBLE OUTLET		SINGLE COMBINATION	
	WT. (lbs.)	PRICE	WT. (lbs.)	PRICE	WT. (lbs.)	PRICE
12" X Stub		554.00		838.00		590.00
Red Top C. T.	27	03320012	42	03330012	35	03420012
Hook Type	26	03220012	40	703230012	N/A	N/A
12" X 5"		590.00		1046.00		624.00
Red Top C. T.	29	03311205	44	03331205	36	703411205
Hook Type	27	703211205	42	703231205	N/A	N/A
12" X 6"		607.00		1055.00		624.00
Red Top C. T.	30	03311206	45	03331206	37	03411206
Hook Type	28	703211206	43	703231206	N/A	N/A
12" X 7"		607.00		1055.00		624.00
Red Top C. T.	31	03311207	45½	03331207	38	703411207
Hook Type	29	703211207	45½	703231207	N/A	N/A
12" X 8"		607.00		1055.00		624.00
Red Top C. T.	32	03311208	46	03331208	39	03411208
Hook Type	30	03211208	44	03231208	N/A	N/A
12" X 10"		607.00		1055.00		734.00
Red Top C. T.	33	03311210	46½	03331210	40	03411210
Hook Type	31	03211210	46½	03231210	N/A	N/A
12" X 12"		647.00		1055.00		734.00
Red Top C. T.	34	03311212	47	03331212	41	03411212
Hook Type	32	03211212	45	03231212	N/A	N/A
14" X Stub		1044.00		1259.00		1091.00
Red Top C. T.	47	03320014	56	03330014	54	703420014
Hook Type	45	03220014	54	703230014	N/A	N/A
14" X 8"		1075.00		1375.00		1109.00
Red Top C. T.	49	03311408	58	03331408	56	703411408
Hook Type	47	03211408	56	703231408	N/A	N/A
14" X 10"		1075.00		1375.00		1109.00
Red Top C. T.	51	03311410	58½	03331410	58	03411410
Hook Type	49	03211410	58½	703231410	N/A	N/A
14" X 12"		1340.00		1756.00		N/A
Red Top C. T.	52	03311412	59	03331412		-----
Hook Type	50	03211412	57	703231412		-----
14" X 15" X Stub		1340.00		1756.00		1375.00
Red Top C. T.	55	03320015	60	03330015	60	703420015
Hook Type	53	03220015	58	703230015	N/A	N/A
16" X Stub		Special Order		N/A		N/A
Red Top C. T.	N/A	N/A	N/A	N/A		-----
Hook Type	41	703220016	43	N/A		-----
16" X 8"		Special Order		N/A		N/A
Red Top C. T.	N/A	N/A	N/A	N/A		-----
Hook Type	43	703211608	45	N/A		-----
16" X 10"		Special Order		N/A		N/A
Red Top C. T.	N/A	N/A	N/A	N/A		-----
Hook Type	45	703211610	46	N/A		-----

Note that 16" and larger are fabricated valves and are Special Order only.

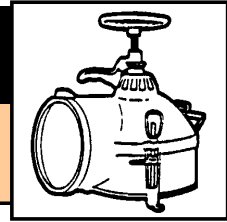
**UNIVERSAL HYDRANT - FABRICATED  
WITH GASKETED OUTLET (EXCEPT STUB)  
CONTINUED**

HYDRANT SIZE BODY X OUTLET	<u>SINGLE OUTLET</u>		<u>DOUBLE OUTLET</u>		<u>SINGLE COMBINATION</u>			
	WT. (lbs.)	PRICE	WT. (lbs.)	PRICE	WT. (lbs.)	PRICE		
16" x 12"		Special Order	N/A	N/A				
Red Top C. T.	N/A	N/A	-	-	-	-	-	-
Sunshine C. T.	N/A	N/A	-	-	-	-	-	-
Hook Type	44	703211612	-	-	-	-	-	-
18" x Stub		Special Order	N/A	N/A				
Red Top C. T.	N/A	N/A	-	-	-	-	-	-
Sunshine C. T.	N/A	N/A	-	-	-	-	-	-
Hook Type	48	03220018	-	-	-	-	-	-
18" x 8"		Special Order	N/A	N/A				
Red Top C. T.	N/A	N/A	-	-	-	-	-	-
Sunshine C. T.	N/A	N/A	-	-	-	-	-	-
Hook Type	50	703211808	-	-	-	-	-	-
18" x 10"		Special Order	N/A	N/A				
Red Top C. T.	N/A	N/A	-	-	-	-	-	-
Sunshine C. T.	N/A	N/A	-	-	-	-	-	-
Hook Type	50 ½	03211810	-	-	-	-	-	-
18" x 12"		Special Order	N/A	N/A				
Red Top C. T.	N/A	N/A	-	-	-	-	-	-
Sunshine C. T.	N/A	N/A	-	-	-	-	-	-
Hook Type	51	03211812	-	-	-	-	-	-
Add for each O.D.	4"	5"	6"	7"	8"	10"	12"	15"
Straight Outlet	65.00	65.00	65.00	74.00	74.00	74.00	76.00	76.00
	703204100	703205100	703206100	703207100	703208100	703210100	703212100	703215100

**WELD-ON (ROUNDBACK)**
**HYDRANT COUPLER ADAPTORS**

PRICING ON REQUEST

**with GASKET FOR UNIVERSAL HYDRANTS**

HYDRANT SIZE	COUPLER DIAMETER						
	4"	5"	6"	7"	8"	10"	12"
6"	97506004	97506005	97506006				
8"	97508004	97508005	97508006	97508007	97508008		
10"		97510005	97510006	97510007	97510008	97510010	
12"			97512006	97512007	97512008	97512010	97512012
14"			97514006		97514008	97514010	97514012

**Roundback Gasket for Universal Hydrants**

GASKET SIZE	PART #	HYDRANT BODY SIZE						
		6"	8"	10"	12"	14"	16"	18"
4"	43504034	N/A	N/A	N/A	N/A	N/A	N/A	N/A
5"	43505034	8.00	8.00	8.00	8.00	8.00	8.00	8.00
6"	43506034	9.00	9.00	9.00	9.00	9.00	9.00	9.00
7"	43507034		10.00	10.00	10.00	10.00	10.00	10.00
8"	43508034		11.00	11.00	11.00	11.00	11.00	11.00
10"	43510034			12.00	12.00	12.00	12.00	12.00
12"	43512034				17.00	17.00	17.00	17.00

Note that 16" and larger are fabricated valves and are Special Order only.

		<b>PARTS FOR UNIVERSAL HYDRANT (CENTER TENSION OR HOOK TYPE)</b>					
<b>PART</b>	<b>6"</b>	<b>8"</b>	<b>10"</b>	<b>12"</b>	<b>14"</b>	<b>16"</b>	<b>18"</b>
Body (Single Outlet)	264.00 98206002	362.00 98208002	430.00 98210002	477.00 98212002	595.00 98214002	737.00 98216002	896.00 98218002
Body (Double Outlet)	N/A	N/A	N/A	632.00 98212003	824.00 98214003	911.00 98216003	1,048.00 98218003
Bottom Gasket	27.00 43506032	30.00 43508032	33.00 43510032	38.00 43512032	46.00 43514032	52.00 43516032	59.00 43518032
O-Ring Seals(pr)	5.00 98200005	5.00 98200005	5.00 98200005	5.00 98200005	5.00 98200005	5.00 98200005	5.00 98200005
Bail Handle	10.00 98200006	10.00 98200006	10.00 98200006	10.00 98200006	10.00 98200006	10.00 98200006	10.00 98200006
C.T. Screw (Brass)	N/A	60.00 98208000	62.00 98210000	67.00 98212000	75.00 98214000	N/A	N/A
Hook Screw (Aluminum)	36.00 98201007	36.00 98201007	46.00 98202007	48.00 98203007	54.00 98204007	60.00 98205007	60.00 98205007
C.T. Clutch (Steel)	N/A	46.00 98200008	46.00 98200008	46.00 98200008	46.00 98200008	N/A	N/A
Hook Clutch (Aluminum)	30.00 98299001	30.00 98299001	30.00 98299001	30.00 98299001	30.00 98299001	30.00 98299001	30.00 98299001
Clutch Bolt W / Nut	5.00 98200009	5.00 98200009	5.00 98200009	5.00 98200009	5.00 98200009	5.00 98200009	5.00 98200009
C.T. Brass Washer	N/A	4.00 98200010	4.00 98200010	4.00 98200010	4.00 98200010	N/A	N/A
C.T. Lift Nut Assembly	N/A	60.00 98200012	60.00 98200012	60.00 98200012	60.00 98200012	N/A	N/A
C.T. Lift Nut	N/A	42.00 98200013	42.00 98200013	42.00 98200013	42.00 98200013	N/A	N/A
C.T. Lift Handle	N/A	14.00 98200004	14.00 98200004	14.00 98200004	14.00 98200004	N/A	N/A
C.T. Lift Pin	N/A	5.00 98200015	5.00 98200015	5.00 98200015	5.00 98200015	N/A	N/A
Side Hook Assembly (ea)	57.00 98200016	57.00 98200016	57.00 98201016	69.00 98202016	69.00 98202016	69.00 98202016	69.00 98202016
Hook Stem	13.00 98200017	17.00 98201017	21.00 98202017	21.00 98202017	21.00 98202017	21.00 98202017	21.00 98202017
Hook Washer	2.00 98200018	2.00 98200018	2.00 98200018	2.00 98200018	2.00 98200018	2.00 98200018	2.00 98200018
Hook Handle	5.00 98200019	5.00 98200019	5.00 98200019	5.00 98200019	5.00 98200019	5.00 98200019	5.00 98200019
Hook Pin	2.00 98200020	2.00 98200020	2.00 98200020	2.00 98200020	2.00 98200020	2.00 98200020	2.00 98200020
Hook Spring	5.00 98200021	5.00 98200021	6.00 98201021	6.00 98201021	7.00 98202021	7.00 98202021	7.00 98202021
Hook Stirrup Nut	15.00 98200022	15.00 98200022	15.00 98200022	15.00 98200022	15.00 98200022	15.00 98200022	15.00 98200022
Handwheel	37.00 98200000	37.00 98200000	37.00 98200000	37.00 98200000	37.00 98200000	37.00 98200000	37.00 98200000
Weld-on Hook Lug	18.00 98200023	18.00 98200023	18.00 98200023	18.00 98200023	18.00 98200023	18.00 98200023	18.00 98200023

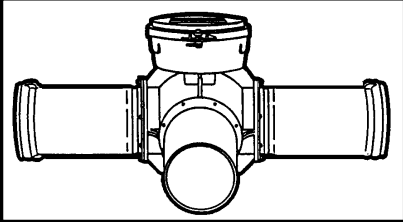
<b>Waterman</b>		<b>HP-500 SURGE VALVE</b>		
<b>SIZE</b>	<b>WT. (lbs.)</b>			
LVC-7 Controller [1]	703606070	call for pricing		
6" Body Unit	20			
	703806010	call for pricing		
6" Weld Flange Kit [2]	37			
	703806012	call for pricing		
6" Coupler Kit [3]	52			
	703806031	call for pricing		
8" Body Unit	29			
	703808010	call for pricing		
8" Weld Flange Kit [2]	46			
	703808012	call for pricing		
8" Coupler Kit [3]	61			
	703808031	call for pricing		
10" Body Unit [2]	42			
	703810010	call for pricing		
10" Weld Flange Kit	59			
	703810012	call for pricing		
10" Coupler Kit [3]	79			
	703810031	call for pricing		
<b>Parts for HP-500 Surge Valve</b>				
		6"	8"	10"
Body Bushings (2 reg'd) ea.		122.00	122.00	122.00
		03800001	03800001	03800001
O-Ring		6.00	6.00	6.00
		03800003	03800003	03800003
Disc		215.00	216.00	252.00
		703806004	103552	703810004
Shaft		205.00	221.00	237.00
		71042421	71042422	106042
Shaft Shoulder Bolt		20.00	20.00	20.00
		1045	1045	1045
NUT		6.00	6.00	6.00
		2518	2518	2518
WASHER		9.00	9.00	9.00
		2932	2932	2932
12 Volt Battery		70.00		
		78613217		

[1] Includes Solar Pack and Motor Drive

[2] Specify size requirements for Welding Flanges

[3] Includes One Male Outlet and Two Female Couplers

Complete valve needs, LVC-7 Controller, Body Unit and Weld Flange / Coupler Kit



## IN-GROUND - EMBEDDED DAIRY FLUSH VALVE



12" DFV-E-CIP-PIP complete	1490.00
	04112001
12" DFV-E-CIP-IPS complete	1490.00
	04112010
15" DFV-E-4 complete	1823.00
	04115001
15" DFV-E-CIP-PIP complete	2,590.00
	04115002

### PARTS FOR IN-GROUND - EMBEDDED DAIRY FLUSH VALVE

SIZE	BLADDER	GRATE	FRAME	COVER	HOSE GUARD	GASKET
12"	347.00	352.00	352.00	352.00	105.00	8.00
	04100010	107869	107867	107872	71078751	43512001
15"	479.00	378.00	1129.00	368.00	105.00	15.00
	04100011	107900	108197	109259	71078752	43516001

Note that 15" is double bladder

## HYDRANT TYPE DAIRY FLUSH VALVE

Size	Price
DFV-M-4 12" with Manual Operator	773.00 04212001
DFV-B-4 12" with Cushion Bladder Operator	1038.00 04212004
DFV-P-4 12" with Pneumatic Operator	1836.00 04212003

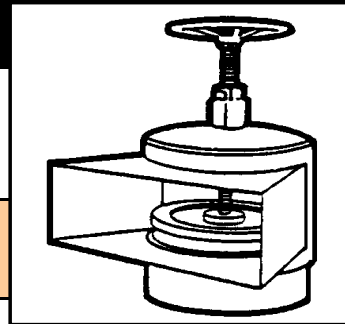

### PARTS FOR HYDRANT TYPE DAIRY FLUSH VALVE

Body	Bronze Stem	Lift Nut	Retaining Nut	Packed Cover	Rubber Packing	Handwheel	Air Spring Bladder	Bolt On Nut Pocket
680.00	196.00	21.00	4.00	102.00	8.00	37.00	347.00	29.00
40512042	42612042	80212042	80212001	41212040	43512001	98200000	04100010	93012000

## AIR VENTS, PRESSURE RELIEF VALVES, CHECK VALVES AND BUTTERFLY VALVES

Pages

Air Vents and Pressure Relief Valves are designed to protect an irrigation system.



**AV-150**

The Waterman AV-150 exhausts air from the pipeline during filling and has a secondary use as a vacuum relief during emptying the line.

28



**AVP-1**

Air Vent / Vacuum Relief Valves should be used at every 1300 feet of a pipeline, at TEE's, elbows, high points and end of line.

28



**CR-101**

The size of vent is determined by the diameter of the pipeline. A good rule of thumb is 25% of the pipe diameter = vent size. 8" pipe uses 2" vent, 12" pipe, use 3" vent.

Continous Acting Air Vent / Vacuum Relief Valves exhaust entrained air during system operation

29-30



**AA-96**

Air Vents are available in cast iron, cast aluminum, and plastic and range in size 3/4" to 4"

Pressure Relief Valves protect the pipeline from surges and unexpected blockage or closure of valving in the system. The Pressure Relief Valve should be set to protect the weakest point of the system.

31-33

Pressure Relief Valves are available in aluminum and cast iron and can be protected by a housing. The housing on the 'D' Model diverts flow away from the pump stand or filter.



**PF-25F**

For Check Valves installed on the end of a line use the Waterman PF-25f flanged or PF-25w compression style Pump Flap Check Valve

34-35

The flanged model PF-25f has standard 125# flange drilling.



**PC-30**

Check Valves prevent backflow in a pipeline. Check Valves are available in cast iron, cast aluminum, and galvanized steel. Check valves are installed using gasketed compression fittings or bolted to flanges.

36



**CPC-30**

The Waterman CPC-30 Chemigation Check Valve features the required Air Vent and Low Pressure Drain Valve.

37-38



Butterfly Valves are excellent end of line and inline valves. Butterfly Valves are high pressure valves for the irrigation industry and are available with both lever operators and handwheel operators.



**VBE-W**

Extensions are available for buried service and Butterfly Valves are easily adapted to electric, pneumatic and hydraulic automatic

40



## MODEL AV-150 AIR VENT AND VACUUM RELIEF VALVE

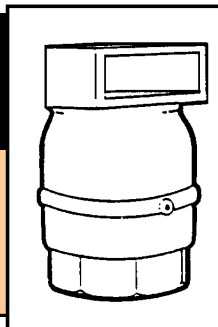

Size (in.) NPT	Wt. (lbs.)	Price Each
1½"	1	33.00 04800001
2"	1.5	38.00 04801000
3"	3	83.00 04802001
4"	6	136.00 04804001

### PARTS FOR MODEL AV-150 AIR VENT AND VACUUM RELIEF VALVE

Size	Body	Baffle	Float Ball	Seat Seal
1½"	26.00 40500048	8.00 46000048	12.00 47048150	3.00 43201047
2"	31.00 40501048	10.00 46001048	15.00 47048212	4.00 43201049
3"	72.00 40503048	13.00 46003048	17.00 47048321	6.00 43203048
4"	123.00 40504048	14.00 46004048	19.00 47048400	6.00 43204048

## MODEL AVP-1 AIR VENT AND VACUUM RELIEF VALVE

Size (NPT)	Vent Size	Wt. (lbs.)	Price (each)
1"	1"	0.5	19.00 04601001
2"	2"	4	53.00 04602001
3"	3"	12	92.00 04603001

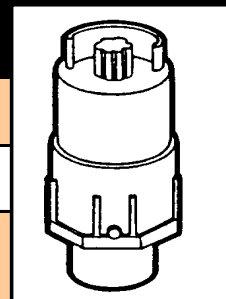

<b>Waterman</b>		<b>MODEL CR-101 CONTINUOUS ACTING AIR VENT AND VACUUM RELIEF VALVE</b>	
<b>SIZE</b>	<b>VENT SIZE</b>	<b>WT. (lbs.)</b>	<b>PRICE EACH</b>
2"	2"	1.5	205.00 05802010
3"	3"	16	231.00 05803010
4"	4"	22	293.00 05804010

<b>PARTS FOR MODEL CR-100 and CR-101 CONTINUOUS ACTING AIR VENT AND VACUUM RELIEF VALVE</b>			
<b>Part</b>	<b>2"</b>	<b>3"</b>	<b>4"</b>
Base (cast iron)	71.00 40602058	88.00 40603058	114.00 40604058
Body (aluminum)	111.00 40502058	134.00 40503058	170.00 40504058
Poppet Assy.	49.00 45902058	54.00 45903058	61.00 45904058
Guide Only (same prt # for all)	12.00 52502312	12.00 52502312	12.00 52502312
Poppet Only	29.00 45802058	32.00 45803058	35.00 45804058
Indicator Knob	4.00 51001001	4.00 51001001	4.00 51001001
Studs & Nuts (ea.) (Number Req'd.)	4.00 (3) 2519	4.00 (4) 2519	4.00 (6) 2519
Body Gasket (O-Ring)	5.00 43200001	5.00 43505001	5.00 43504100
Float Cylinder	56.00 47002057	88.00 47003058	88.00 47003058
Baffle	6.00 46002058	10.00 46003058	12.00 46004058



## MODEL CRP-8 CONTINUOUS ACTING AIR VENT AND VACUUM RELIEF VALVE

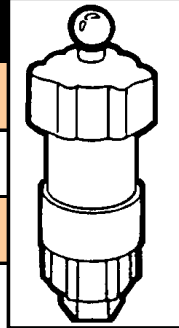

Size (NPT)	Vent Size	Weight (lbs.)	Price each
1"	1"	1.5	68.00 05900001
2"	2"	5	132.00 05900002
3"	3"	12.5	185.00 05900003

### PARTS FOR MODEL CRP-8

Part	2"	3"
Body	50.00 40502059	59.00 1800455
Baffle	8.00 46002059	9.00 46003059
Poppet	41.00 45902059	42.00 45903059
Indicator Knob	4.00 51001001	4.00 51001001
Float Ball	56.00 47002058	88.00 47003058
Base	29.00 40602059	78.00 40603059
Base Gasket	4.00 43501200	5.00 43501300
S.S. Bolt & Washer (ea)	4.00 81302001	4.00 81302001
(Number Req'd)	(4 Req'd)	(4 Req'd)

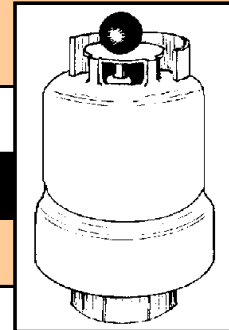

### MODEL CRP-9 CONTINUOUS ACTING AIR VENT AND VACUUM RELIEF VALVE

SIZE	VENT SIZE	WT. (lbs.)	
2"	2"	4	74.00 05902000



### MODEL AA-6B PRESSURE RELIEF VALVE

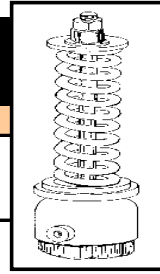

AA-6B FACTORY SET	Size	Wt. (lbs.)	11-65 psi	66-120 psi
PLEASE SPECIFY SETTING	2"	10	142.00 06001001	142.00 06001002
	2 1/2"	10	144.00 06002001	144.00 06002002

### MODEL AA-60D w/ PORTED DISCHARGE OUTLET FACTORY SET PRESSURE RELIEF VALVE

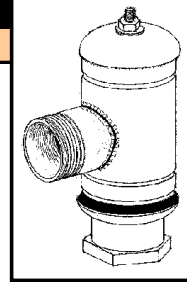

	Size	Wt. (lbs.)	11-40 psi	41-120 psi
	2"	13	284.00 22002063	284.00 22002064

Note: AA-60D comes with a Female Port

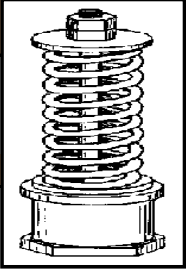
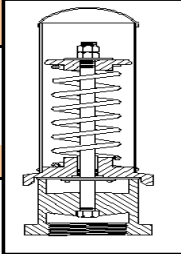
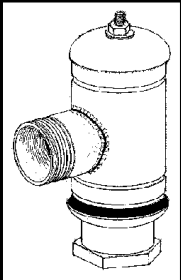

## MODEL AA-96B, AA-96C & AA-96D PRESSURE RELIEF VALVE (Aluminum Body)

<b>AA-96B FACTORY SET - SPECIFY SETTING</b>				
Size	11-40 psi	41-100 psi	101-150 psi	
3"	177.00	177.00	194.00	
Wt. (lbs.)	14	18	20 1/2	
	06003041	06003101	06003121	
Size	11-34 psi	35-60 psi	61-105 psi	106-150 psi
4"	222.00	222.00	222.00	231.00
Wt. (lbs.)	27 1/2"	33	38	42
	06004021	06004041	06004101	06004121
<b>AA-96C FACTORY SET - SPECIFY SETTING (w/cover)</b>				
Size	11-40 psi	41-100 psi	101-150 psi	
3"	203.00	203.00	233.00	
Wt. (lbs.)	16	20	22 1/2	
	06003042	06003102	06003122	
Size	11-34 psi	35-60 psi	61-105 psi	106-150 psi
4"	255.00	255.00	262.00	289.00
Wt. (lbs.)	35	35	40	43
	06004022	06004042	06004102	06004122
<b>AA-96D FACTORY SET - SPECIFY SETTING w/Ported Discharge Outlet</b>				
Size	11-40 psi	41-100 psi	101-120 psi	
3"	298.00	298.00	327.00	
Wt. (lbs.)	16	20	22 1/2	
	706003043	706003103	706003122	
Size	11-34 psi	35-60 psi	61-105 psi	101-120 psi
4"	364.00	364.00	364.00	405.00
Wt. (lbs.)	36	36	41	44
	706004023	706004043	706004103	706004123

Note: AA-96D comes with a Female Port

## MODEL AA-9 PRESSURE RELIEF VALVE (Cast Iron Body)

<b>LOW HEAD - SPECIFY PRESSURE SETTING</b>		
Size (NPT)	11-35 PSI	36-80 PSI
6"	593.00	593.00
Wt. (lbs)	76	76
	06206022	06206080
<b>HIGH HEAD - SPECIFY PRESSURE SETTING</b>		
Size (NPT)	81-120 PSI	
6"	709.00	
Wt. (lbs)	76	
	06206120	

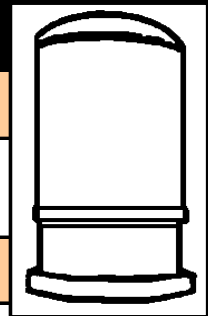

					
DESCRIPTION	----- AA-6 PARTS -----		----- AA-96 PARTS -----		----- AA-9 PARTS -----
	2"	2½"	3"	4"	6"
Base	81.00	81.00	111.00	120.00	146.00
	40601060	40602060	40603061	40604061	40606062
Cover	49.00	49.00	52.00	60.00	181.00
	41003062	41003062	41003061	41004061	41006062
Cover Gasket (set)	10.00	10.00	10.00	15.00	39.00
	43303062	43303062	43303061	43304061	43306062
Gasket Retainers w/Screws	10.00	10.00	10.00	11.00	21.00
	43103062	43103062	43103061	43104061	43106062
O-Ring Seals(ea) (2 req'd)	3.00	3.00	3.00	3.00	3.00
	43200114	43200114	43200114	43200114	43200216
Spring Retainer	N/A	N/A	35.00	35.00	104.00
			57101060	57101060	57106062
Spring Guide Washer	3.00	3.00	N/A	N/A	N/A
	82005052	82005052			
Seal Wire	4.00	4.00	4.00	4.00	4.00
	64201001	64201001	64201001	64201001	64201001
Spring Cover w/ Drive Screws	N/A	N/A	48.00	56.00	86.00
			56503062	56504062	56506062
Guide Rod Nuts	4.00	4.00	4.00	4.00	4.00
	80306050	80306050	80306050	80306050	80306050

Note that 2" AA-6 parts fit on 2" AA-60D

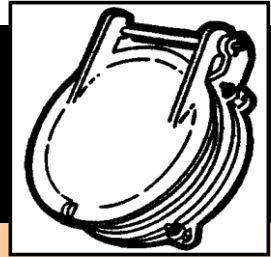
**MODEL PF25W RED TOP® CAST IRON FLAP VALVE  
COMPRESSION STYLE**

**NOT FOR DUCTILE PIPE**

-----W/ Iron Cover -----

-----W/ Bronze Seats -----

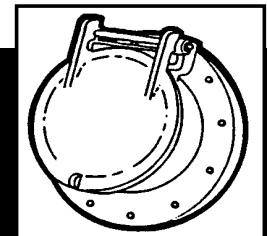
Size	Wt. (lbs.)	With I.D. Gasket	With O.D. Gasket	With SDR Gasket	Size	Wt. (lbs.)	With I.D. Gasket	With O.D. Gasket	With SDR Gasket
4"	13	188.00 06604001	188.00 06604002	195.00 06604006	4"	14	328.00 06604021	333.00 06604022	333.00 06604023
6"	19	223.00 06606001	223.00 06606002	229.00 06606006	6"	20	609.00 06606021	640.00 06606022	640.00 06606023
8"	21	247.00 06608001	247.00 06608002	259.00 06608006	8"	22	692.00 06608021	692.00 06608022	692.00 06608023
10"	27	318.00 06610001	318.00 06610002	331.00 06610006	10"	29	831.00 06610021	831.00 06610022	831.00 06610023
12"	44	394.00 06612001	394.00 06612002	408.00 06612006	12"	46	994.00 06612021	1001.00 06612022	1001.00 06612023
14"	62	525.00 06614001	N/A	536.00 06614006	14"	65	1234.00 06614021	NA	1,234.00 06614023

**MODEL PF25F RED TOP® CAST IRON FLAP VALVE  
FLANGEBACK STYLE**

Size	With Iron Cover/Neoprene Seats [1]		With Bronze Seats	
	Wt. (lbs.)	Price	Wt. (lbs.)	Price
4"	20	284.00 06404001	20	446.00 06404002
6"	36	370.00 06406001	36	776.00 06406002
8"	48	391.00 06408001	49	855.00 06408002
10"	68	491.00 06410001	69	1017.00 06410002
12"	176	690.00 06412001	178	1316.00 06412002
14"	130	896.00 06414001	133	1641.00 06414002
16"	145	1109.00 06416001	148	2192.00 06416002
18"	181	1753.00 06418001	185	2715.00 06418002
20"	245	2095.00 06420001	250	3157.00 06420002
24"	360	2490.00 06424001	370	3847.00 06424002

[1] Iron Cover is Standard with neoprene seats

Note: ID Gasket for IPS Pipe

Note: OD Gasket is for PIP Pipe



## PARTS FOR MODEL PF-25 RED TOP® CAST IRON FLAP VALVE COMPRESSION AND FLANGEBACK STYLES

Part	4"	5"	6"	8"	10"	12"	14"	16"	18"	20"	24"
<b>COMP-BODY:</b>											
Iron	116.00	158.00	191.00	242.00	300.00	331.00	499.00	N/A	N/A	N/A	N/A
Seat	40504066	40505066	40506066	40508066	40510066	40512066	40514066				
Bronze	168.00	184.00	305.00	344.00	382.00	432.00	611.00	N/A	N/A	N/A	N/A
Seat	40504067	40505067	40506067	40508067	40510067	40512067	40514067				
<b>FLANGEBACK BODY</b>											
Iron	205.00	N/A	315.00	321.00	326.00	426.00	479.00	998.00	1444.00	1838.00	2048.00
Seat	40504062		40506062	40508062	40510062	40512062	40514062	40516062	40518062	40520062	40524062
Bronze	317.00	N/A	531.00	633.00	709.00	730.00	1035.00	1654.00	2258.00	2672.00	2830.00
Seat	40504063		40506063	40508063	40510063	40512063	40514063	40516063	40518063	40520063	40524063
<b>COVER:</b>											
Iron	126.00	147.00	168.00	221.00	271.00	326.00	387.00	746.00	1258.00	1269.00	1687.00
Seat	41204064	41205064	41206064	41208064	41210064	41212064	41214064	41216064	41218064	41220064	41224064
Bronze	315.00	331.00	536.00	697.00	718.00	817.00	1108.00	1155.00	1481.00	1791.00	1995.00
Seat	41004065	41005065	41006065	41008065	41010065	41012065	41014065	41016065	41018065	41020065	41024065
Aluminum*	Call	Call	Call	Call	Call	Call	Call	N/A	N/A	N/A	N/A
	41004066	41005066	41006066	41008066	41010066	41012066	41014066				
COVER	20.00	21.00	28.00	28.00	31.00	33.00	37.00	52.00	54.00	59.00	72.00
PACKNG ONLY	43504066	43505066	43506066	43508066	43510066	43512066	43514066	43516066	43518066	43520066	43524066
FOLLOW RING:	17.00	24.00	31.00	32.00	37.00	61.00	93.00	N/A	N/A	N/A	N/A
	58504066	58505066	58506066	58508066	58510066	58512066	58514066				
RING BOLTS:	5.00	5.00	5.00	5.00	5.00	5.00	5.00	N/A	N/A	N/A	N/A
(each)	80802250	80802250	80803250	80803250	80803250	80803250	80803250				
HINGE PIN	19.00	20.00	21.00	23.00	24.00	26.00	32.00	34.00	38.00	41.00	51.00
ASSY.:	82605510	82605560	82605698	82605860	82651098	82651148	82651335	82651510	82661660	82661860	82681910
<b>PIPE SEAL GASKETS:</b>											
I.D. Size	21.00	24.00	24.00	25.00	26.00	34.00	35.00	N/A	N/A	N/A	N/A
(each)	43504010	43505010	43506010	43508010	43510010	43512010	43514010				
O.D. Size	20.00	23.00	23.00	24.00	25.00	32.00	35.00	N/A	N/A	N/A	N/A
(each)	43504020	43505020	43506020	43508020	43510020	43512020	43514020				

\* Call factory for price and availbilty on Aluminum Cover

Bronze seat is machined into the cover or body.



## MODEL PC-30 SWING CHECK VALVE

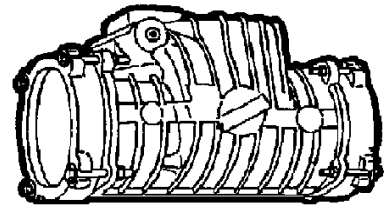

Size	Weight (lbs.)	----- PRICE -----		
		With I.D. Gasket	With O.D. Gasket	With SDR-35 Gasket
4"	15	314.00 06804001	326.00 06804010	326.00 06804020
6"	23	366.00 06806001	380.00 06806010	380.00 06806020
8"	32	473.00 06808001	486.00 06808010	486.00 06808020
10"	53	766.00 06810001	777.00 06810010	777.00 06810020

NOTE: FOR MODEL PC-30-L (Exterior lever arm for manual by-pass) Add \$160.00 to above prices

### PARTS FOR MODEL PC-30 SWING CHECK VALVE

	4"	5"	6"	8"	10"
Body	329.00 40504068	395.00 40505068	426.00 40506068	466.00 40508068	743.00 40510068
Cover with Gasket (flapper)	69.00 41204068	88.00 41205068	104.00 41206068	128.00 41208068	189.00 41210068
Cover Bolt	11.00 80805200	11.00 80805200	11.00 80805200	11.00 80805200	11.00 80805200
Hinge Arm	32.00 45004068	37.00 45005068	44.00 45006068	50.00 45008068	59.00 45010068
Hinge Pin	10.00 82505362	10.00 82505450	12.00 82505425	12.00 82505425	13.00 82505550
Hinge Bushing(2 needed)	6.00 83005071	6.00 83005071	6.00 83005071	6.00 83005071	6.00 83005071
Hinge Plugs (each) with grease zerk	7.00 80005002	7.00 80005002	7.00 80005002	7.00 80005002	7.00 80005002
Follow Ring (one for ea. side)	15.00 58504068	21.00 58505068	31.00 58506068	35.00 58508068	51.00 58510068
Ring Bolt (4 per side) Price per each bolt	5.00 80802250	5.00 80803250	5.00 80804300	5.00 80805300	5.00 80805300
Pipe Seal Gasket Std.(each)(ID)	21.00 43504010	24.00 43505010	24.00 43506010	25.00 43508010	26.00 43510010
Pipe Seal Gasket O.D.(each)	20.00 43504020	23.00 43505020	23.00 43506020	24.00 43508020	25.00 43510020
Pipe Seal Gasket SDR-35	25.00 43504030	25.00 43505030	25.00 43506030	26.00 43508030	28.00 43510030
Hinge Torsion Spring	N/A	N/A	9.00 105854	9.00 105854	9.00 105854
Bumper with Screw	4.00 53501023	4.00 53501023	4.00 53501023	4.00 53501023	4.00 53501023
Stainless Washer (each)	3.00 82005051	3.00 82005051	3.00 82005051	3.00 82005051	3.00 2928

Note: ID Gasket is for IPS Pipe

Note: OD Gasket is for PIP Pipe



## MODEL CPC-30B

CERTIFIED [1]  
BACK FLOW PREVENTION SYSTEM

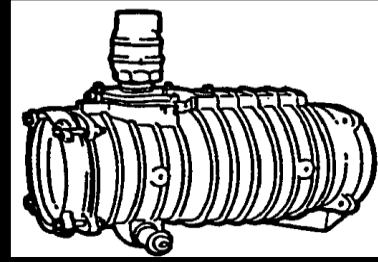

Pipe Size	Flange X Flange	Compression X Compression[2]	Flange X Compression[3]		
4"	638.00	638.00	638.00		
Weight (lbs.)	26	26	26		
	06804120	06804110	06804130		
6"	655.00	655.00	655.00		
Weight (lbs.)	34	34	34		
	06806120	06806110	06806130		
8"	754.00	754.00	754.00		
Weight (lbs.)	42	42	42		
	06808120	06808110	06808130		
10"	1062.00	1062.00	1062.00		
Weight (lbs.)	60	60	60		
	06810120	06810110	06810130		
12"	1512.00	N/A	N/A		
Weight (lbs.)	139				
	06812120				
<b>Add for CPC-30B as required</b>	2" AV-150 40.00 04801000	2" AVP-1 53.00 04602001	3/4" D-34 Low Pressure Dran Valve 17.00 06806316		
<b>Add for Flange Bolts &amp; Flange Gaskets:</b>		<b>4"</b>	<b>6"</b>	<b>8"</b>	<b>10"</b> <b>12"</b>
Flange Bolt Set		29.00	36.00	62.00	62.00    62.00
Zinc Plated		86004122	86006122	86008001	86010122    86012122
Flange Gasket (one)		14.00	16.00	25.00	29.00    37.00
		43504122	43506068	43508068	43510122    43512122

[1] Call for current list of States where certified

Price includes DRAIN VALVE and GASKETED INSPECTION PORT

[2] Includes: Gasketed Inspection Port, 2" PVC Pipe Nipple, Two O.D. Gaskets, One Set of Retainer Studs, Nuts & Washers

[3] Includes: Gasketed Inspection Port, 2" PVC Pipe Nipple, One O.D. Gasket, One Set of Retainer Bolts, Nuts & Washers

		<b>PARTS FOR MODEL CPC-30B</b>				
	4"	6"	8"	10"	12"	
Body F x F	481.00	515.00	628.00	950.00	1,229.00	
	06804300	06806300	06808300	06810300	06812300	
Body C x C	416.00	455.00	532.00	615.00	NA	
	06804301	06806301	06808301	068103001	06812301	
Body F x C	457.00	488.00	562.00	782.00	NA	
	06804302	06806302	06808302	06810302	06812302	
Cover w/seat	82.00	93.00	100.00	138.00	200.00	
	06804303	06806303	06808303	06810303	06812303	
Spring Hinge Assy.	105.00	111.00	116.00	121.00	126.00	
	06804304	06806304	06808304	06810304	06812304	
Cover Shoulder Bolt	11.00	11.00	11.00	11.00	11.00	
	06804305	06806305	06808305	06810305	06812305	
Cover Lock Nut	6.00	6.00	6.00	6.00	6.00	
	06804306	06806306	06808306	06810306	06812306	
Hinge Brkt. Hex Bolt	6.00	6.00	6.00	6.00	6.00	
	06804307	06806307	06808307	06810307	06812307	
Hinge Brkt. Washer Seal	7.00	7.00	7.00	7.00	7.00	
	06804308	06806308	06808308	06810308	06812308	
Inspection Port Stud Nut & Washer (set of 3)	12.00	12.00	12.00	12.00	12.00	
	06801309	06801309	06801309	06801309	06801309	
Compression Ring Bolt, Washer & Nut (ea.)*	6.00	6.00	6.00	6.00	6.00	
	06804310	06806310	06808310	06810310	06812310	
Inspection Port Cover (Tapped 2" IPT)	40.00	40.00	40.00	40.00	40.00	
	06801311	06801311	06801311	06801311	06801311	
Inspection Port Gasket	12.00	12.00	12.00	12.00	12.00	
	06801312	06801312	06801312	06801312	06801312	
Compression Follow Ring	15.00	31.00	35.00	51.00	N/A	
	58504068	58506068	58508068	58510068		
Compression Gasket I.D.	12.00	14.00	14.00	19.00	N/A	
	06804314	06806314	06808314	06810314		
Compression Gasket O.D.	20.00	20.00	24.00	27.00	N/A	
	06804315	06806315	06808315	06810315		
Low Pressure Drain Valve	17.00	17.00	17.00	17.00	17.00	
	06806316	06806316	06806316	06806316	06806316	
Plastic Pipe Plugs Only (ea.) (Included with body)	6.00	6.00	6.00	6.00	6.00	
	450-007	450-007	450-007	450-007	450-007	

\* Three per set on each follow ring for 4". Four per set on each follow ring for 6" thru 12".

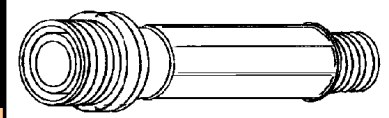
**MODEL D-34  
LOW PRESSURE  
DRAIN VALVE**

Size	Part #	ea.
3/4"	06806316	17.00

**MODEL PC-150 SPLIT DISC CHECK VALVE**

Size	Weight (lbs.)	Price	Flange Gasket
4"	21	403.00	14.00
		07004001	43504122
6"	35	458.00	16.00
		07006001	43506068
8"	62	693.00	25.00
		07008001	43508122
10"	90	979.00	29.00
		07010001	43510122
12"	146	1,337.00	37.00
		07012001	43512122

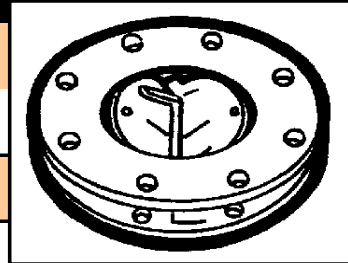
**PARTS FOR MODEL PC-150 SPLIT DISC CHECK VALVE**

	4"	6"	8"	10"	12"
Body	281.00	296.00	532.00	601.00	620.00
	40504001	40506001	40508001	40510001	40512001
Seat Ring	99.00	125.00	136.00	147.00	218.00
	60004001	60006001	60008001	60010001	60012001
Flap Cover (pair)	128.00	151.00	308.00	413.00	453.00
	41004101	41006101	41008101	41010101	41012101
Springs (2 Req)	15.00	15.00	15.00	21.00	24.00
	57004001	57006001	57008001	57010001	57012001
Hinge Rod	11.00	11.00	20.00	21.00	25.00
	52802006	52802006	52803008	52803010	52805012
Pipe Plug	5.00	5.00	5.00	5.00	5.00
	80002002	80002002	80002002	80002002	80002002
Flat Head Screws(4)	4.00	4.00	10.00	10.00	10.00
Price per each	81410062	81410062	81410088	81410088	81410088



**WATERMAN-AQUATIC BUTTERFLY VALVE  
WAFER STYLE (ONE PIECE GASKET LINED)  
150 PSI SERVICE**

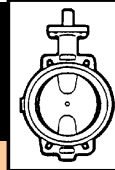

SIZE	W/GEAR OPERATOR		Stainless Disc	Stainless Disc	Add For **-----	
	W/LEVER OPERATOR	& HANDWHEEL	W/LEVER OPERATOR	GEAR OPERATED	48" EXTENSION	72" EXTENSION
3"	82.00	147.00	Special Order		184.00	221.00
Wt. (lbs.)	23703001	23703101	23703002	NA	23703048	23703072
	16	29	16			
4"	105.00	168.00	Special Order		184.00	221.00
Wt. (lbs.)	23704001	23704101	23704002	NA	23704048	23704072
	19	35	19			
5"	124.00	189.00			184.00	221.00
Wt. (lbs.)	23705001	23705101	NA	NA	23705048	23705072
	25	40				
6"	153.00	205.00	Special Order	Special Order	184.00	221.00
Wt. (lbs.)	23706001	23706101	23706002	23706102	23706048	23706072
	33	44	33	44		
8"	205.00	331.00	Special Order	Special Order	210.00	242.00
Wt. (lbs.)	23708001	23708101	23708002	23708102	23708048	23708072
	48	65	48	65		
10"	328.00	434.00	Special Order	Special Order	210.00	242.00
Wt. (lbs.)	23710001	23710101	23710002	23710102	23710048	23710072
	69	86	69	86		
12"	427.00	555.00	Special Order	Special Order	210.00	242.00
Wt. (lbs.)	23712001	23712101	23712002	23712102	23712048	23712072
	99	116	99	116		

**MODEL VBE2-W INDUSTRIAL TYPE BUTTERFLY VALVE  
WAFER STYLE (ONE PIECE GASKET LINED)**

150 PSI SERVICE

SIZE	W/GEAR OPERATOR		W/GEAR OPERATOR	WITH MOTOR OPERATOR	Add For **-----			
	WITHOUT OPERATOR	W/LEVER OPERATOR	& 2" SQ. NUT BURIED SERVICE	HANDWHEEL	48" EXTENSION	72" EXTENSION	96" EXTENSION	
4"	289.00	347.00	575.00	604.00	3,513.00	184.00	247.00	268.00
Wt. (lbs.)	21704002	21704011	21704050	21704031	21704040	55304048	55304072	55304096
	14	19	34	35				
6"	342.00	415.00	630.00	660.00	3,565.00	214.00	247.00	247.00
Wt. (lbs.)	21706002	21706011	21706050	21706031	21706040	55306048	55306072	55306096
	24	33	44	50				
8"	462.00	536.00	751.00	783.00	3,683.00	214.00	247.00	268.00
Wt. (lbs.)	21708002	21708011	21708050	21708031	21708040	55308048	55308072	55308096
	39	48	59	65				
10"	620.00	704.00	903.00	935.00	3,843.00	247.00	260.00	268.00
Wt. (lbs.)	21710002	21710011	21710050	21710031	21710040	55310048	55310072	55310096
	65	69	80	86				
12"	924.00	1,019.00	1,218.00	1,245.00	4,153.00	260.00	260.00	268.00
Wt. (lbs.)	21712002	21712011	21712050	21712031	21712040	55312048	55312072	55312096
	90	99	110	116				

**FLANGES, FLANGE GASKETS and FLANGE BOLTS**

SIZE	3"	4"	6"	8"	10"	12" *
Full Face Flange (ea)	NA	20.00	29.00	39.00	52.00	73.00
Wt. (lbs.)		97004001	97006001	97008001	97010001	97012001
		5	8	12	15	22
HDPE Flange Adaptor		Special Order	Special Order	Special Order	Special Order	Special Order
		65604013	65606013	65608013	65610013	65612013
Bolt Set [1]	For Steel Flange(shorter)	29.00	36.00	36.00	62.00	62.00
		86004122	86006122	86008122	86010122	86012122
Wt. (lbs.)		7.5	11	12	24	27
		(8)	(8)	(8)	(12)	(12)
	For Plastic Flange(longer)	29.00	32.00	39.00	88.00	88.00
		86004217	86006217	86008217	86010217	86012217
Plastic Flange w/PIP Insert		34.00	52.00	92.00	144.00	156.00
		65604217	65606217	65608217	65610217	65612217

\* 10 and 12 inch are NOT RECOMMENDED for use with lever operator over 115psi or 50 feet of head.

\*\* \$15.00 NET adder to assemble valves to extensions for 3" to 12"

[1] One Set required for two flanges - Used with Wafer Style Valves





## WATERMAN BACKWASH VALVES

Size	Price
4"	Call Factory

### WATERMAN J-5 AND J-6 MAGNAWASH BACKWASH VALVE REPAIR KITS

Description	Price
J-5 Washer Kit	Call Factory 22804009
J-5 Diaphragm	Call Factory 106804
J-6 Seal Kit	Call Factory 22804010
J-6 Diaphragm Assembly Kit	Call Factory 22804011

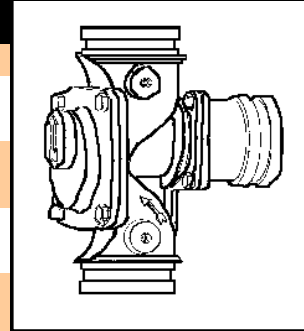

J-5 and J-6 Kits are in stock, please call for pricing.



# C

## LINE GATES, CANAL GATES SLIDE GATES, FLAP GATES



**H-30**

The Waterman H-30 is an 'IN-LINE' gate with 6 different frame types. The HUB END -1 line gate is for concrete pipe, the TYPE 4 is for 80 lb and 100lb PIP, CIP IPS/PIP cement to OD of PVC Pipe. The heavy duty Flange x Flange body attaches to flanged pipe.

Pages

43-49



**C-10**

The Waterman C-10 Canal Gate is designed for 10' seating head and 0' unseating head. Head is the rated pressure from the center line of the pipe opening to the top of the gate head rail where the lift is attached.

59-68

All slide and canal gates are rated for a specific head. The Waterman C-20 Canal Gate is rated for 20' seating and 10' unseating head.

69-75



**AC-31**

Seating head is the pressure from the FACE of the gate, pushing the slide against the frame and unseating head is the pressure from the back of the gate.

Waterman manufactures superior fabricated slide gates from A-36 steel to aluminum to stainless steel. Fabricated gates attach to a wall thimble, directly to the wall, or to a pipe or pipe flange.

76

The AC-31 is an aluminum canal gate and can attach to PVC, CMP, (corrugated metal pipe), HDPE or a wall.



**F-10**

Waterman has a complete line of cast iron and fabricated flap and drainage gates configured Circular, Square or Rectangular. All Waterman gates come either flatback, flanged back or spigotback.

77-79



**AF-41**

Flatback gates bolt to a headwall. Spigotback gates attach to CMP and PVC pipe. The Waterman Type 6 frame is typically for HDPE pipe but can be custom rolled to fit any application.

80



## MODEL HV-30 RED TOP ® VEE NOTCH LINE GATE

Model HV-30 is special order only

Size	PRICE W/CAST IRON SEATS				PRICE W/PERMANENT BRONZE SEATS [1]			
	Hub Ends	Spigots for PVC	CIP HUB	Flanged 25 lb. ASA HV-30FF	Hub Ends	Spigots for PVC	CIP HUB	Flanged 25 lb. ASA HV-30FF
6" Wt.	N/A	Call 85 10606010	Call 84 10806010	Call 94 10406010	N/A	Call 85 10606011	Call 84 10806011	Call 94 10406011
8" Wt.	Call 86 10208010	Call 104 10608010	Call 102 10808010	Call 114 10408010	Call 86 10208011	Call 104 10608011	Call 102 10808011	Call 114 10408011
10" Wt.	Call 97 10210010	Call 130 10610010	Call 127 10810010	Call 141 10410010	Call 97 10210011	Call 130 10610011	Call 127 10810011	Call 141 10410011
12" Wt.	Call 153 10212010	Call 179 10612010	Call 171 10812010	Call 192 10412010	Call 155 10212011	Call 181 10612011	Call 171 10812011	Call 194 10412011
14" Wt.	Call 192 10214010	Call 205 10614010	N/A	Call 210 10414010	Call 194 10214011	Call 207 10614011	N/A	Call 212 10414011
15"x14" Wt.	N/A	Call 210 10615010	Call 208 10815010	N/A	N/A	Call 213 10615011	Call 210 10815011	N/A

Note 304ss stems are available upon request

Model HV-30 Line Gates are special order only please contact factory for pricing and leadtime.

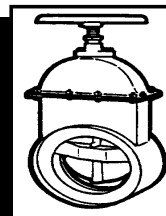

## MODEL H-30 RED TOP ® LINE GATE

Size	PRICE W/CAST IRON SEATS				PRICE W/PERMANENT BRONZE SEATS [1]			
	(cement) Hub Ends	Spigots for PVC	CIP/IPS HUB	Flanged(IPS) 25 lb. ASA	Hub Ends	Spigots for PVC	IPS CIP	Flanged 25 lb. ASA
	H-30-1	H-30-4	HUB	H-30-FF	H-30-1	H-30-4	HUB	H-30-FF
6"	N/A	819.00	938.00	965.00	N/A	Call	Call	Call
Wt.		75	74	84		75	74	84
		10606000	10806000	10406000		10606001	10806001	10406001
8"	961.00	975.00	1087.00	1266.00	Call	Call	Call	Call
Wt.	76	94	92	104	76	94	92	104
	10208000	10608000	10808000	10408000	10208001	10608001	10808001	10408001
10"	972.00	1061.00	1298.00	1554.00	Call	Call	Call	Call
Wt.	87	120	117	131	87	120	117	131
	10210000	10610000	10810000	10410000	10210001	10610001	10810001	10410001
12"	1140.00	1273.00	1470.00	1843.00	Call	Call	Call	Call
Wt.	143	169	161	182	145	171	161	184
	10212000	10612000	10812000	10412000	10212001	10612001	10812001	10412001
14"	1376.00	N/A	N/A	2085.00	Call	N/A	N/A	Call
Wt.	182			200	184			202
	10214000			10414000	10214001			10414001
15"x14"	N/A	1518.00	1948.00	N/A	N/A	Call	Call	N/A
Wt.		200	194			203	193	
		10615000	10815000			10615001	10815001	
16"	1943.00	N/A	N/A	2505.00	Call	N/A	N/A	Call
Wt.	245			390	249			394
	10216000			10416000	10216001			10416001
18"	2253.00	2820.00	N/A	3156.00	Call	Call	N/A	Call
Wt.	305	325		610	309	329		614
	10218000	10618000		10418000	10218001	10618001		10418001
20"	3198.00	3597.00	N/A	4200.00	Call	Call	N/A	Call
Wt.	462	480		960	467	485		965
	10220000	10620000		10420000	10220001	10620001		10420001
24"	6983.00	8154.00	N/A	9130.00	Call	Call	N/A	Call
Wt.	883	931		998	889	937		1004
	10224000	10624000		10424000	10224001	10624001		10424001
30"	16158.00	N/A	N/A	17606.00	Call	N/A	N/A	Call
Wt.	2440			2550	2446			2556
	10230000			10430000	10230001			10430001
36"	N/A	N/A	N/A	25725.00	N/A	N/A	N/A	Call
Wt.				4290				
				10436000				

[1] H30 Line Gates with bronze seats are special order only please contact factory for pricing and leadtime.

\* PIP change last three digits on the part number to 002 (only for the CIP cast iron seats).

\*For CIP with brz seats change last 3 digits to 003.

HDPE Flange Adaptor P.O.A

Type 4 is designed for PIP 63. Other sizes can be quoted upon request, please specify size required.

Note that H30 Line Gates are available with 304ss stems, request pricing from factory.



## PARTS FOR H-30 RED TOP® LINE GATE

	6"	8"	10"	12"	14"	15"x14"
Body - Cast Iron W/Hub Ends	N/A	422.00 40508020	491.00 40510020	615.00 40512020	772.00 40514020	N/A
Body W/Type 4 Spigots (Iron Seats)	495.00 40506060	609.00 40508060	727.00 40510060	908.00 40512060	N/A	1155.00 40515060
Body W/Flanged Ends (Iron Seats)	791.00 40506080	791.00 40508080	973.00 40510080	1383.00 40512080	1541.00 40514080	N/A
Body W/CIP Hubs (Iron Seats)	570.00 40506040	593.00 40508040	669.00 40510040	834.00 40512040	N/A	N/A
Body Perm. Bronze W/Hub Ends	N/A	Call 40408021	Call 40410021	Call 40412021	Call 40414021	N/A
Body W/Type 4 Spigots (Brass Seats)	Call 40406061	Call 40408061	Call 40410061	Call 40412061	N/A	Call 40415061
Body W/Flanged Ends (Brass Seats)	N/A	Call 40408080	Call 40410080	Call 40412080	Call 40414080	N/A
Body W/CIP Hubs	849.00 40406040	884.00 40408040	1002.00 40410040	1237.00 40412040	N/A	N/A
Bonnet	124.00 42006102	136.00 42008102	146.00 42010102	214.00 42012102	262.00 42014102	262.00 42014102
Bonnet Gasket	18.00 43506102	21.00 43508102	23.00 43510102	34.00 43512102	38.00 43514102	38.00 43514102
Bonnet Bolts (set bolts and nuts)	6.00 80803150	6.00 80804150	6.00 80804150	7.00 80805150	7.00 80805150	7.00 80805150
Arch	44.00 71101890002	48.00 71101920002	54.00 71102000002	65.00 71102060002	88.00 71102120002	88.00 71102120002
Brass Screw (Stem) with collar**	135.00 42706102	141.00 42708102	155.00 42710102	162.00 42712102	163.00 42714102	163.00 42714102
Brass Screw Nut (Thrust Nut)	37.00 42106102	37.00 42106102	37.00 42106102	37.00 42106102	37.00 42106102	37.00 42106102
Pkg. Gland Assy* (includes everything)	82.00 64506102	82.00 64506102	82.00 64506102	83.00 64512102	83.00 64512102	83.00 64512102
Pkg. Gland Body (individual)	35.00 64806102	35.00 64806102	35.00 64806102	35.00 64812102	35.00 64812102	35.00 64812102
Pkg Gland Nut	32.00 64606102	32.00 64606102	32.00 64606102	32.00 64606102	32.00 64606102	32.00 64606102
Pkg. Gland Pkg.	8.00 43408040	8.00 43408040	8.00 43408040	8.00 43408040	8.00 43408040	8.00 43408040
Pkg. Gland Gasket	5.00 43506112	5.00 43506112	5.00 43506112	5.00 43512112	5.00 43512112	5.00 43512112

\*Packing Gland Assembly includes body, nut, packing and gasket

\*\*304ss double lead stems will be available September 2010. Call factory for pricing.

Contact factory for current pricing on H30 bronze line gate line parts.

		<b>PARTS FOR H-30 RED TOP ® LINE GATE</b>				
		<b>CONTINUED</b>				
	<b>6"</b>	<b>8"</b>	<b>10"</b>	<b>12"</b>	<b>14"</b>	<b>15"X14"</b>
Pkg. Gland Bolts	4.00	4.00	4.00	4.00	4.00	4.00
	2277	2277	2277	2277	2277	2277
Handwheel	53.00	53.00	53.00	53.00	53.00	53.00
	49512060	49512060	49512060	49512060	49512060	49512060
Hdwl. W/Spinner	61.00	61.00	61.00	61.00	61.00	61.00
	49512061	49512061	49512061	49512061	49512061	49512061
Ext. Stub per foot	8.00	8.00	8.00	8.00	8.00	8.00
	90058010	90058010	90058010	90058010	90058010	90058010
Set Screws (ea.)	4.00	4.00	4.00	4.00	4.00	4.00
	1261	1261	1261	1261	1261	1261
Connector	26.00	26.00	26.00	26.00	26.00	26.00
stem ext. (coupling)	55500060	55500060	55500060	55500060	55500060	55500060
Cover - Cast Iron	184.00	195.00	200.00	205.00	216.00	216.00
	41006050	41008050	41010050	41012050	41014050	41014050
Cover - Perm Bronze	Call	Call	Call	Call	Call	Call
	41406051	41408051	41410051	41412051	41414051	41414051
2" Sq Op Nut 5/8" shaft	37.00	37.00	37.00	37.00	37.00	37.00
for 6" to 14" Valves	49202060	49202060	49202060	49202060	49202060	49202075

Contact factory for current pricing on H30 bronze line gate line parts.

**PARTS FOR H-30 RED TOP® LINE GATE**  
 CONTINUED

	16"	18"	20"	24"	30"	36"
Body - Cast Iron	1169.00	1383.00	2188.00	3700.00	6569.00	POA
W/Hub Ends	40516020	40518020	40520020	40524020	40530020	
Body W/Type 4 Spigots (Iron Seats)	1457.00	1986.00	2565.00	NA	NA	NA
	40516060	40518060	40520060			
Body W/Flanged Ends (Iron Seats)	2182.00	2601.00	3473.00	6315.00	11034.00	15448.00
	40516080	40518080	40520080	40524080	40530080	40536080
Body Perm. Bronze W/Hub Ends	Call	Call	Call	Call	Call	Call
	40416021	40418021	40420021	40424021		
Body W/Type 4 Spigots (Brass Seats)	Call	Call	Call	NA	NA	NA
	40416061	40418061	40420061			
Body W/Flanged Ends (Brass Seats)	Call	Call	Call	Call	Call	Call
	40416081	40418081	40420081	40424081	40430081	
Bonnet	324.00	524.00	710.00	1592.00	2539.00	7662.00
	42016102	42018102	42020102	42024102	42030102	42036102
Bonnet Gasket	41.00	48.00	56.00	91.00	108.00	390.00
	43516102	43518102	43520102	43524102	43530102	43536102
Bonnet Bolts (Set bolts and nuts)	11.00	11.00	16.00	27.00	32.00	32.00
	80806150	80806150	80807150	80808150	80809150	80809150
Arch	163.00	175.00	196.00	224.00	730.00	1416.00
	71102180002	71102250002	71102280002	71111010002	71114740002	71119000002
Brass Screw (Stem) (with collar)**	219.00	243.00	300.00	390.00	N/A	N/A
	42716102	42718102	42720102	42724102		
Brass Screw Nut (Thrust Nut)	58.00	58.00	97.00	122.00	122.00	147.00
	42116102	42116102	42120102	42124102	42124102	42136102
Pkg. Gland Assy* (includes everything)	99.00	99.00	121.00	174.00	238.00	461.00
	64516102	64516102	64520102	64524102	64530102	64536102
Pkg. Gland Body (individual)	42.00	42.00	71.00	121.00	132.00	209.00
	64816102	64816102	64820102	64824102	64830102	64836102
Pkg. Gland Nut	32.00	32.00	56.00	NA	NA	NA
	64616102	64616102	64620102			
Pkg. Gland Pkg.	8.00	8.00	8.00	10.00	10.00	10.00
	43410030	43410030	43411020	43415050	43415050	43415050
Pkg. Gland Gasket	5.00	5.00	7.00	9.00	9.00	10.00
	43512112	43512112	43520112	43524112	43530112	43536112

\*Packing Gland Assembly includes body, nut, packing and gasket

\*\*304ss double lead stems will be available September 2010. Call factory for pricing.

Contact factory for current pricing on H30 bronze line gate line parts.

**PARTS FOR H-30 RED TOP ® LINE GATE**  
 CONTINUED

	16"	18"	20"	24"	30"	36"
Pkg. Gland Bolts	4.00 2277	4.00 2277	5.00 2041	5.00 2048	5.00 2048	5.00 2048
Handwheel	68.00 49514076	68.00 49514076	71.00 49514094	215.00 49518126	234.00 49524132	451.00 49530126
Hdwl. W/Spinner	80.00 49614076	80.00 49614076	80.00 49614076	N/A	N/A	N/A
Ext. Stub per foot	10.00 90034010	10.00 90034010	10.00 90034010	11.00 90078010	11.00 90078010	11.00 90078010
Set Screws (ea.)	4.00 1261	4.00 1261	4.00 1261	4.00 1261	4.00 1261	4.00 1261
Connector stem ext.	27.00 55500075	27.00 55500075	29.00 55500080	33.00 55500125	33.00 55500125	33.00 55500125
Cover - Cast Iron	229.00 41016050	305.00 41018050	552.00 41020050	870.00 41024050	1775.00 41030050	4702.00 41036050
Cover - Perm Bronze	Call 41416051	Call 41418051	Call 41420051	Call 41424051	Call 41430051	Call 41436051
Pkg Gland Sleeve (brass)				Call	Call	Call
Pkg. Gland Retainer				Call	Call	Call
Pkg.Gland Studs (ea.)(stainless)				Call	Call	Call
Pkg. Gland Nuts (ea.)				Call	Call	Call
Stainless Screw				Call	Call	Call
Eye Bolt				Call	Call	Call
2" Sq. Op. Nut	37.00 49202075	37.00 49202075	37.00 49202875	37.00 49202125	37.00 49202125	37.00 49202125

Contact factory for current pricing on H30 bronze line gate line parts.



## MODEL HD-30 RED TOP® DOUBLE DISC LINE GATE

Model HD-30 is special order only

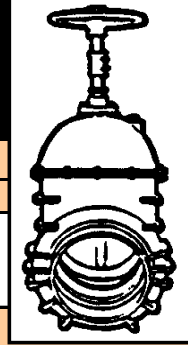

HD-30 with Iron Seats					HD-30 Bronze Seats			
SIZE	HD-30-1	HD-30-4	HD-30-FF	HD-30-CIP	HD-30-1	HD-30-4	HD-30-FF	HD-30-CIP
8"	Call	Call	Call	Call	Call	Call	Call	Call
Wt.	80	80	85	80	80	80	85	80
	11008001	11408001	11808001	11608001	11008002	11408002	11808002	11608002
10"	Call	Call	Call	Call	Call	Call	Call	Call
Wt.	95	136	144	157	95	136	144	157
	11010001	11410001	11810001	11610001	11010002	11410002	11810002	11610002
12"	Call	Call	Call	Call	Call	Call	Call	Call
Wt.	150	188	195	212	150	188	195	212
	11012001	11412001	11812001	11612001	11012002	11412002	11812002	11612002
14"	Call	N/A	Call	N/A	Call	N/A	Call	N/A
Wt.	190		215		190		215	
	11014001		11814001		11014002		11814002	
15"x14"	N/A	Call	N/A	N/A	N/A	Call	N/A	N/A
Wt.		205				205		
		11415001				11415002		
16"	Call	N/A	Call	N/A	Call	N/A	Call	N/A
Wt.	265		365		270		375	
	11016001		11816001		11016002		11816002	
18"	Call	Call	Call	N/A	Call	Call	Call	N/A
Wt.	325	345	630		330	350	635	
	11018001	11418001	11818001		11018002	11418002	11818002	
20"	Call	Call	Call	N/A	Call	Call	Call	N/A
Wt.	485	502	983		491	508	989	
	11020001	11420001	11820001		11020002	11420002	11820002	

### PARTS FOR MODEL HD-30 RED TOP® DOUBLE DISC LINE GATE

SIZE	8"	10"	12"	14"	15"x14"	16"	18"	20"
Body-Iron Seats	422.00	491.00	615.00	772.00	N/A	1169.00	1383.00	2188.00
W/Hub Ends	40508020	40510020	40512020	40514020		40516020	40518020	40520020
W/Type 4 Spigots	609.00	727.00	908.00	N/A	1155.00	NA	1986.00	2565.00
	40508060	40510060	40512060		40515060		40518060	40520060
W/Flanged Ends	792.00	975.00	1383.00	1543.00	N/A	2184.00	2613.00	3473.00
	40508081	40510081	40512081	40514081		40516081	40518081	40520081
W/CIP Hubs	709.00	812.00	998.00	N/A	N/A	N/A	N/A	N/A
	40508045	40510045	40512045					
Body-Brass Seats	Call	Call	Call	Call	N/A	Call	Call	Call
W/Hub Ends	40408021	40410021	40412021	40414021		40416021	40418021	40420021
W/Type 4 Spigots	1032.00	1163.00	1423.00	N/A	1685.00	2168.00	3032.00	3716.00
	40408061	40410061	40412061		40415061	40416061	40418061	40420061
W/Flanged Ends	1134.00	1309.00	1784.00	2082.00	N/A	2890.00	3486.00	4655.00
	40408082	40410082	40412082	40414082		40416082	40418082	40420082
W/CIP Hubs	1132.00	1248.00	1438.00	N/A	N/A	N/A	N/A	N/A
	40408046	40410046	40412046					
Cover-Iron Seat	144.00	168.00	182.00	276.00	276.00	315.00	449.00	702.00
	41008060	41010060	41012060	41014060	41015060	41016060	41018060	41020060
Cover-Brass Seat	Call	Call	Call	Call	Call	Call	Call	Call
	41408061	41410061	41412061	41414061	41415061	41416061	41418061	41420061

NOTE: Model HD-30 Line Gates are special order only please contact factory for pricing and leadtime.

HDPE Flange Adaptor P.O.A.

Type 4 is designed for PIP 63. Other sizes can be quoted upon request, please specify size required.

\*\*304ss double lead stems will be available September 2010. Call factory for pricing.

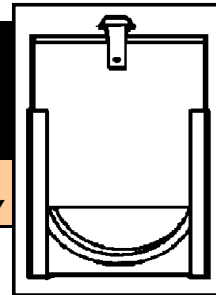
**MODEL C-2 GALVANIZED DISTRIBUTING GATE**

SIZE	STYLE	----- TUBE LENGTH -----			SLIDE ONLY
		STANDARD	MAXIMUM	MINIMUM	
1 1/2"	STANDARD	2"	3"	1 5/8"	4.00 41801236
		7.00	7.00	7.00	
		13601001	13601010	13601030	
2"	STANDARD*	2"			4.00 41802236
		7.00	7.00	7.00	
	13603030	13602010	13602030		
	CRIMPED	10.00	10.00	10.00	
13603040	13602020	13602040			
2 1/2"	STANDARD*	2"	4"	1 3/4"	4.00 41802238
		7.00	7.00	7.00	
	13602050	13602060	13602080		
	CRIMPED	10.00	10.00	7.00	
13602055	13602070	13602090			
3"	STANDARD*	3"	4"	2"	4.00 41803236
		7.00	7.00	7.00	
	13603001	13603010	13603030		
	CRIMPED	10.00	10.00	10.00	
13603005	13603020	13603040			
4"	STANDRD*	3"	4"	2"	4.00 41804236
		10.00	10.00	10.00	
	13604001	13604010	13604030		
	CRIMPED	13.00	13.00	13.00	
13604005	13604020	13604040			

NOTE: 2", 3" and 4" fit plastic or concrete.

\* NOTE: 2" MINIMUM, 2-1/2" STANDARD, 3" MINIMUM AND 4" STANDARD ARE STOCKED  
PARTS WILL BE 13602030, 13602050, 13603030 and 13604040



## MODEL C-2 GALVANIZED DISTRIBUTING GATE

CONTINUED

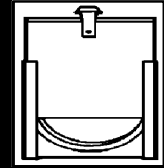

SIZE	TUBE LENGTH STANDARD	WT. (lbs.)	CMP, CONCRETE		PVC	HDPE	W/CIP	W/CIP	CMP, CONCRETE	SLIDE ONLY
			W/STRAP HANDLE	W/TUBE INSERT	W/TUBE 4	W/TUBE 6	FRAME	FRAME	W/2' STRAP HANDLE	W/STRAP HANDLE
6"	3"	2.5	29.00	29.00	29.00	44.00	44.00	29.00	11.00	
			13606001	13606002	13606006	13606021	13606031	13606010	41706236	
8"	3"	3	34.00	34.00	34.00	53.00	53.00	34.00	12.00	
			13608001	13608002	13608006	13608021	13608031	13608010	41708236	
10"	3"	4	39.00	39.00	39.00	74.00	74.00	39.00	13.00	
			13610001	13610002	13610006	13610021	13610031	13610010	41710236	
12"	3"	5	48.00	48.00	48.00	79.00	79.00	48.00	14.00	
			13612001	13612002	13612006	13612021	13612031	13612010	41712236	
14"	3"	6	54.00					54.00	17.00	
			13614001					13614010	41714236	
15"	4½"	8.5	80.00	80.00	80.00			80.00	23.00	
			13615001	13615002	13615006			13615010	41715236	
16"	4½"	9	93.00					93.00	30.00	
			13616001					13616010	41716236	
18"	4½"	14	128.00	128.00	128.00			128.00	36.00	
			13618001	13618002	13618006			13618010	41718236	
20"	4½"	17	200.00	200.00	200.00				54.00	
			13620001	13620002	13620006				41720236	
21"	4½"	18	205.00						58.00	
			13621001						41721236	
24"	4½"	20	279.00		279.00				79.00	
			13624001		13624006				41724236	
30"		26	409.00						103.00	
			13630001						41730236	

\* TYPE 6 fits HDPE, SDR35 or other pipe but customer must specify pipe ID for proper fit when ordering. HDPE style inserts into pipe.

\*Check with sales for TYPE 6 sizing limitations when inquiring and ordering.

C2 Type 4 gates insert into pipe requiring epoxy cement to bond. You must specify class of PIP when ordering. (PIP 63, 80, 100)

Note: CIP-IPS or CIP-PIP Cements to the O.D. of pipe using PVC Cement. Type 4 epoxies to the I.D. of pipe.

Specify Corrugated Metal, Concrete, PVC type, SDR35 or HDPE when ordering.

Red Handle is for CMP or Concrete Pipe. Black Handle is for Type 4 connections

Nominal Size	C-2	C-2-4
	Rolled Collar OD	Rolled Collar OD
6	5.75"	5.88"
8	7.75"	7.88"
10	9.75"	9.88"
12	11.63"	11.88"
14	13.75"	-
15	14.75"	14.88"
16	15.75"	-
18	17.63"	17.88"
20	19.75"	19.88"
21	20.75"	20.88"
24	23.63"	23.88"
30	-	-

C2 is for concrete pipe.

C-2-4 is for PIP 50 so confirm ID of pipe. For PIP 63, 80 and

PIP 100 order TYPE 6 Frame and state inside diameter of pipe.

Dimensions are + or - 1/8 inch.

**PARTS FOR MODEL C-3 DIAMOND GATE**

<b>SIZE</b>	<b>SLIDE ONLY</b>
1"	5.00 41800138
1½"	5.00 41801138
2"	5.00 41802138

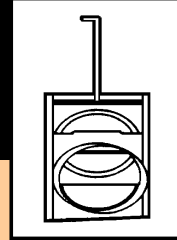

## C-8 SURESEAL AND C-8E ECONOMY DITCH GATES

SIZE	WT. (LBS.)	CONCRETE	80/100	CONCRETE	HDPE	CIP-IPS	CIP-PIP	80/100	FOOT OF EXTRA HANDLE
		CMP MODEL C-8	PIP MODEL C-8-4*	CMP MODEL C-8E				PIP MODEL C-8E-4*	
4"	5	79.00 14604001	79.00 14704001	74.00 14804001	74.00 14804006	74.00 14804011	74.00 14804013		7.00 50001146
6"	7	90.00 14606001	90.00 14706001	84.00 14806001	84.00 14806006	84.00 14806011	84.00 14806013	84.00 14906001	7.00 50001146
8"	9	100.00 14608001	100.00 14708001	95.00 14808001	95.00 14808006	95.00 14808011	95.00 14808013	95.00 14908001	7.00 50001146
10"	12	116.00 14610001	116.00 14710001	111.00 14810001	111.00 14810006	111.00 14810011	111.00 14810013	111.00 14910001	7.00 50001146
12"	14	126.00 14612001	126.00 14712001	116.00 14812001	116.00 14812006	116.00 14812011	116.00 14812013	116.00 14912001	7.00 50001146
14"	17	168.00 14614001	168.00 14714001	158.00 14814001	158.00 14814006			158.00 14914001	7.00 50001146
15"	17	200.00 14615001	200.00 14715001	189.00 14815001	189.00 14815006			189.00 14915001	7.00 50001146
16"	20	231.00 14616001	231.00 14716001	210.00 14816001	210.00 14816006			210.00 14916001	8.00 50002146
18"	24			273.00 14818001	273.00 14818006			273.00 14918001	8.00 50002146
21"	27			336.00 14821001	336.00 14821006				8.00 50002146
24"	30			399.00 14824001	399.00 14824006				8.00 50002146

\*\* TYPE 6 fits HDPE, SDR35 or other pipe but customer must specify pipe ID for proper fit when ordering. HDPE style Inserts into pipe.

\*C8 Type 4 gates insert into pipe requiring epoxy cement to bond. You must specify class of PIP and pipe ID when ordering. (PIP 63, 80, 100)

Note: CIP-IPS or CIP-PIP cements to the O.D. of pipe using PVC Cement. Type 4 epoxies to the I.D. of pipe.

Type 4 and CIP-PIP are not interchangeable.

Specify Corrugated Metal, Concrete, PVC type, SDR35 or HDPE when ordering.

All C8's have rubber gasket--all C8E's do not include a sealing gasket.

Nominal Size	C-8-E		C-8-E PIP		C-8-E IPS		C8		C-8-4 PIP	
	Rolled Collar OD	Rolled Collar OD	Rolled Collar OD	Rolled Collar ID	Rolled Collar OD	Rolled Collar OD	Rolled Collar OD	Rolled Collar OD	Rolled Collar OD	Rolled Collar OD
4	4.0"	-	-	-	4.0"	-	-	-	-	-
6	5.75"	5.88"	6.5"	5.75"	5.88"	-	-	-	-	-
8	7.75"	7.88"	8.62"	7.75"	7.88"	-	-	-	-	-
10	9.75"	9.88"	10.75"	9.75"	9.88"	-	-	-	-	-
12	11.75"	11.88"	12.75"	11.75"	11.88"	-	-	-	-	-
14	13.75"	-	14.75"	13.75"	-	-	-	-	-	-
15	14.75"	14.88"	-	14.75"	14.88"	-	-	-	-	-
16	15.75"	-	-	15.75"	-	-	-	-	-	-
18	17.88"	17.88"	-	-	-	-	-	-	-	-
20	-	19.88"	-	-	-	-	-	-	-	-
21	20.75"	20.88"	-	-	-	-	-	-	-	-
24	23.75"	23.88"	-	-	-	-	-	-	-	-

C8 and C-8-E C8 are for concrete pipe.  
C-8-4 is for PIP 50 so confirm ID of pipe. For PIP 63, 80 and 100 order TYPE 6 Frame and state inside diameter of pipe. Dimensions are + or - 1/8 inch.

**PARTS FOR MODEL C-8 & C-8E DITCH GATES**

SIZE	FRAME	FRAME	SLIDE	SLIDE	ARCH	HANDLE	HANDLE	GUIDE	GUIDE	GASKET
	C-8	C-8E	C-8	C-8E			GUIDE	BOLT	ONLY	
4"	45.00		23.00		7.00	13.00	4.00	3.00	8.00	
	40204146		41704146		44004146	50004146	54501146	80803175	43504146	
6"	55.00	47.00	28.00	19.00	9.00	13.00	4.00	3.00	10.00	
	40206146	40206148	41706146	41706148	44006146	50004146	54501146	80803175	43506146	
8"	65.00	49.00	31.00	21.00	10.00	13.00	4.00	3.00	11.00	
	40208146	40208148	41708146	41708148	44008146	50004146	54501146	80803175	43508146	
10"	71.00	53.00	39.00	26.00	13.00	13.00	4.00	3.00	14.00	
	40210146	40210148	41710146	41710148	44010146	50004146	54501146	80803175	43510146	
12"	74.00	56.00	50.00	28.00	13.00	13.00	4.00	3.00	16.00	
	40212146	40212148	41712146	41712148	44012146	50004146	54501146	80803175	43512146	
14"	92.00	67.00	57.00	41.00	17.00	17.00	4.00	3.00	17.00	
	40214146	40214148	41714146	41714148	44014146	50014146	54501146	80803175	43514146	
15"	104.00	88.00	60.00	46.00	19.00	17.00	4.00	3.00	18.00	
	40215146	40215148	41715146	41715148	44015146	50014146	54502146	80803175	43515146	
16"	119.00	82.00	74.00	50.00	20.00	17.00	4.00	3.00	21.00	
	40216146	40216148	41716146	41716148	44016146	50014146	54502146	80803175	43516146	
18"		101.00		55.00	24.00	21.00	4.00	3.00		
		40218148		41718148	44018146	50018146	54502146	80803175		
21"		126.00		72.00	28.00	21.00	4.00	3.00		
		40221148		41721148	44021146	50021146	54502146	80803175		
24"		139.00		90.00	34.00	21.00	4.00	3.00		
		40224148		41724148	44024146	50021146	54502146	80803175		
EXTRA LENGTH HANDLE				4"-15"		16"-24"				
				7.00	PER FT	8.00	PER FT			
				50001146		50002146				



## MODEL C-9 SLIDE GATE

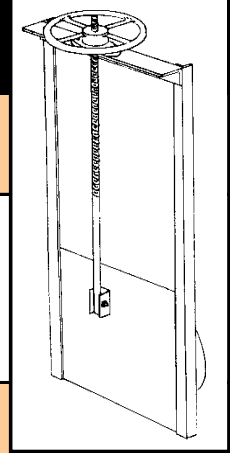

Gate Size	Type	Min. Frame Ht.	PRICE PER FRAME HEIGHT				
			Min.	4 FT.	5 FT.	6 FT.	8 FT.
8"	CMP/CONCRETE C-9	24"	346.00	378.00	403.00	428.00	477.00
			22108024	22108048	22108060	22108072	22108096
	PVC C-9-4	346.00	378.00	403.00	428.00	477.00	
8"	PVC C-9-4	24"	22208024	22208048	22208060	22208072	22208096
			22308024	22308048	22308060	22308072	22308096
	HDPE C-9-6	351.00	384.00	411.00	433.00	511.00	
10"	CMP/CONCRETE C-9	24"	366.00	394.00	431.00	464.00	527.00
			22110024	22110048	22110060	22110072	22110096
	PVC C-9-4	366.00	394.00	431.00	464.00	527.00	
10"	PVC C-9-4	24"	22210024	22210048	22210060	22210072	22210096
			22310024	22310048	22310060	22310072	22310096
	HDPE C-9-6	373.00	393.00	454.00	501.00	596.00	
12"	CMP/CONCRETE C-9	24"	383.00	417.00	443.00	467.00	513.00
			22112024	22112048	22112060	22112072	22112096
	PVC C-9-4	383.00	417.00	443.00	467.00	513.00	
12"	PVC C-9-4	24"	22212024	22212048	22212060	22212072	22212096
			22312024	22312048	22312060	22312072	22312096
	HDPE C-9-6	390.00	423.00	450.00	473.00	520.00	
14"	CMP/CONCRETE C-9	27"	403.00	433.00	457.00	481.00	543.00
			22114027	22114048	22114060	22114072	22114096
	PVC C-9-4	403.00	433.00	457.00	481.00	543.00	
14"	PVC C-9-4	27"	22214027	22214048	22214060	22214072	22214096
			22314027	22314048	22314060	22314072	22314096
	HDPE C-9-6	414.00	445.00	469.00	491.00	562.00	
15"	CMP/CONCRETE C-9	30"	405.00	435.00	461.00	483.00	566.00
			22115030	22115048	22115060	22115072	22115096
	PVC C-9-4	405.00	435.00	461.00	483.00	566.00	
15"	PVC C-9-4	30"	22215030	22215048	22215060	22215072	22215096
			22315030	22315048	22315060	22315072	22315096
	HDPE C-9-6	418.00	450.00	493.00	503.00	587.00	
16"	CMP/CONCRETE C-9	32"	419.00	453.00	479.00	553.00	583.00
			22116032	22116048	22116060	22116072	22116096
	PVC C-9-4	419.00	453.00	479.00	553.00	583.00	
16"	PVC C-9-4	32"	22216032	22216048	22216060	22216072	22216096
			22316032	22316048	22316060	22316072	22316096
	HDPE C-9-6	441.00	468.00	490.00	565.00	594.00	
18"	CMP/CONCRETE C-9	34"	452.00	490.00	516.00	538.00	609.00
			22118034	22118048	22118060	22118072	22118096
	PVC C-9-4	452.00	490.00	516.00	538.00	609.00	
18"	PVC C-9-4	34"	22218034	22218048	22218060	22218072	22218096
			22318034	22318048	22318060	22318072	22318096
	HDPE C-9-6	465.00	504.00	529.00	552.00	622.00	
20"	CMP/CONCRETE C-9	38"	513.00	593.00	622.00	645.00	787.00
			22120138	22120048	22120060	22120072	22120096
	PVC C-9-4	513.00	593.00	622.00	645.00	787.00	
20"	PVC C-9-4	38"	22220138	22220048	22220060	22220072	22220096
			22320138	22320048	22320060	22320072	22320096
	HDPE C-9-6	527.00	608.00	636.00	661.00	801.00	

\* FITS HDPE MUST SPECIFY PIPE ID

Type 4 is designed for PIP 63. Other sizes can be quoted upon request, please specify size required.

Specify Corrugated Metal, Concrete, PVC type or HDPE when ordering.

**MODEL C-9 SLIDE GATE**

CONTINUED

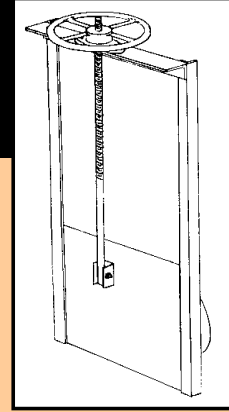

Gate Size	Type	Min. Frame Ht.	PRICE PER FRAME HEIGHT					
			Min.	4 FT.	5 FT.	6 FT.	8 FT.	
21"	CMP/CONCRETE	C-9	40"	519.00	604.00	629.00	655.00	803.00
				22121040	22121048	22121060	22121072	22121096
	PVC	C-9-4		519.00	604.00	629.00	655.00	803.00
				22221040	22221048	22221060	22221072	22221096
	HDPE	C-9-6*		532.00	618.00	642.00	669.00	814.00
				22321040	22321048	22321060	22321072	22321096
24"	CMP/CONCRETE	C-9	44"	769.00	783.00	809.00	837.00	984.00
				22124044	22124048	22124060	22124072	22124096
	PVC	C-9-4		769.00	783.00	809.00	837.00	984.00
				22224044	22224048	22224060	22224072	22224096
	HDPE	C-9-6*		774.00	835.00	888.00	940.00	1045.00
				22324044	22324048	22324060	22324072	22324096
30"	CMP/CONCRETE	C-9	54"	1216.00		1252.00	1336.00	1578.00
				22130054		22130060	22130072	22130096
	PVC	C-9-4		1216.00		1252.00	1336.00	1578.00
				22230054		22230060	22230072	22230096
	HDPE	C-9-6*		1233.00		1270.00	1358.00	1598.00
				22330054		22330060	22330072	22330096

\* FITS HDPE MUST SPECIFY PIPE ID

Type 4 is designed for PIP 63. Other sizes can be quoted upon request, please specify size required.

Specify Corrugated Metal, Concrete, PVC type or HDPE when ordering.



## MODEL AC-9 SLIDE GATE

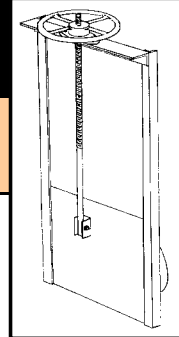

Gate Size	Type	Min. Frame Ht.	PRICE PER FRAME HEIGHT					
			Min.	4 FT.	5 FT.	6 FT.	8 FT.	
8"	CMP/CONCRETE	AC-9	24"	450.00	491.00	513.00	555.00	620.00
				22408024	22408048	22408060	22408072	22408096
	PVC	AC-9-4		450.00	491.00	513.00	555.00	620.00
				22508024	22508048	22508060	22508072	22508096
	HDPE	AC-9-6*		461.00	504.00	536.00	567.00	632.00
				22608024	22608048	22608060	22608072	22608096
10"	CMP/CONCRETE	AC-9	24"	475.00	516.00	550.00	581.00	645.00
				22410024	22410048	22410060	22410072	22410096
	PVC	AC-9-4		475.00	516.00	550.00	581.00	645.00
				22510024	22510048	22510060	22510072	22510096
	HDPE	AC-9-6*		488.00	529.00	562.00	593.00	657.00
				22610024	22610048	22610060	22610072	22610096
12"	CMP/CONCRETE	AC-9	24"	497.00	538.00	570.00	602.00	668.00
				22412024	22412048	22412060	22412072	22412096
	PVC	AC-9-4		497.00	538.00	570.00	602.00	668.00
				22512024	22512048	22512060	22512072	22512096
	HDPE	AC-9-6*		515.00	558.00	590.00	622.00	686.00
				22612024	22612048	22612060	22612072	22612096
14"	CMP/CONCRETE	AC-9	27"	515.00	553.00	584.00	612.00	683.00
				22414027	22414048	22414060	22414072	22414096
	PVC	AC-9-4		515.00	553.00	584.00	612.00	683.00
				22514027	22514048	22514060	22514072	22514096
	HDPE	AC-9-6*		534.00	571.00	603.00	628.00	704.00
				22614027	22614048	22614060	22614072	22614096
15"	CMP/CONCRETE	AC-9	30"	524.00	566.00	600.00	630.00	693.00
				22415030	22415048	22415060	22415072	22415096
	PVC	AC-9-4		524.00	566.00	600.00	630.00	693.00
				22515030	22515048	22515060	22515072	22515096
	HDPE	AC-9-6*		553.00	586.00	620.00	649.00	712.00
				22615030	22615048	22615060	22615072	22615096
16"	CMP/CONCRETE	AC-9	32"	545.00	584.00	621.00	661.00	750.00
				22416032	22416048	22416060	22416072	22416096
	PVC	AC-9-4		545.00	584.00	621.00	661.00	750.00
				22516032	22516048	22516060	22516072	22516096
	HDPE	AC-9-6*		576.00	617.00	672.00	692.00	783.00
				22616032	22616048	22616060	22616072	22616096
18"	CMP/CONCRETE	AC-9	34"	563.00	614.00	641.00	672.00	759.00
				22418034	22418048	22418060	22418072	22418096
	PVC	AC-9-4		563.00	614.00	641.00	672.00	759.00
				22518034	22518048	22518060	22518072	22518096
	HDPE	AC-9-6*		585.00	632.00	660.00	692.00	780.00
				22618034	22618048	22618060	22618072	22618096
20"	CMP/CONCRETE	AC-9	38"	670.00	697.00	693.00	760.00	824.00
				22420038	22420048	22420060	22420072	22420096
	PVC	AC-9-4		670.00	697.00	693.00	760.00	824.00
				22520038	22520048	22520060	22520072	22520096
	HDPE	AC-9-6*		704.00	728.00	760.00	792.00	855.00
				22620038	22620048	22620060	22620072	22620096

\* FITS HDPE MUST SPECIFY PIPE ID

Type 4 is designed for PIP 63. Other sizes can be quoted upon request, please specify size required.

Specify Corrugated Metal, Concrete, PVC type or HDPE when ordering.



## MODEL AC-9 SLIDE GATE

CONTINUED

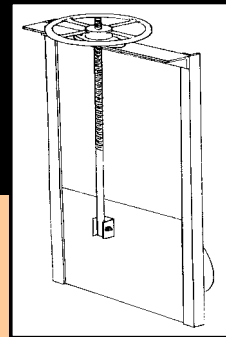

Gate Size	Type	AC-9	Min. Frame Ht.	PRICE PER FRAME HEIGHT				
				Min.	4 FT.	5 FT.	6 FT.	8 FT.
21"	CMP/CONCRETE	AC-9	40"	691.00	723.00	755.00	786.00	843.00
				22421040	22421048	22421060	22421072	22421096
	PVC	AC-9-4	691.00	723.00	755.00	786.00	843.00	
			22521040	22521048	22521060	22521072	22521096	
HDPE	AC-9-6*	724.00	755.00	788.00	817.00	875.00		
		22621040	22621048	22621060	22621072	22621096		
24"	CMP/CONCRETE	AC-9	44"	891.00	956.00	987.00	1076.00	1200.00
				22424044	22424048	22424060	22424072	22424096
	PVC	AC-9-4	891.00	956.00	987.00	1076.00	1200.00	
			22524044	22524048	22524060	22524072	22524096	
HDPE	AC-9-6*	908.00	976.00	1007.00	1095.00	1218.00		
		22624044	22624048	22624060	22624072	22624096		
30"	CMP/CONCRETE	AC-9	54"	1501.00		1501.00	1605.00	1894.00
				22430054		22430060	22430072	22430096
	PVC	AC-9-4	1501.00		1501.00	1605.00	1894.00	
			22530054		22530060	22530072	22530096	
HDPE	AC-9-6*	1645.00		1648.00	1752.00	2041.00		
		22630054		22630060	22630072	22630096		

\* FITS HDPE MUST SPECIFY PIPE ID

Type 4 is designed for PIP 63. Other sizes can be quoted upon request, please specify size required.

Specify Corrugated Metal, Concrete, PVC type or HDPE when ordering.

**MODEL C-10 RED TOP® CANAL GATE  
W / FLATBACK / SPIGOTBACK FRAME**

Gate Size	Standard Frame Height	Weight	Material	Flat Back	Spigot Back	Price Add'l. Foot
6"	24	41	Paint	\$ 563.00	\$ 574.00	45.00
	minumum height is 24"		Galv	599.00	609.00	48.00
						9 Lbs.
8"	24"	47	Paint	601.00	612.00	45.00
	minumum height is 24"		Galv	640.00	650.00	48.00
						9 Lbs.
10"	24"	55	Paint	659.00	670.00	45.00
	minumum height is 24"		Galv	701.00	711.00	48.00
						9 Lbs.
12"	24"	65	Paint	668.00	679.00	45.00
	minumum height is 24"		Galv	711.00	722.00	48.00
						9 Lbs.
14"	36"	69	Paint	783.00	794.00	45.00
	minumum height is 27"		Galv	832.00	844.00	48.00
						9 Lbs.
15"	36"	86	Paint	777.00	789.00	45.00
	minumum height is 30"		Galv	827.00	838.00	48.00
						9 Lbs.
16"	36"	88	Paint	854.00	867.00	45.00
	minumum height is 32"		Galv	909.00	923.00	48.00
						10 Lbs.
18"	36"	116	Paint	958.00	972.00	59.00
	minumum height is 34"		Galv	1,019.00	1,034.00	63.00
						10 Lbs.
20"	48"	151	Paint	1,255.00	1,273.00	59.00
	minumum height is 38"		Galv	1,334.00	1,353.00	63.00
						10 Lbs.
21"	48"	167	Paint	1,314.00	1,333.00	59.00
	minumum height is 40"		Galv	1,397.00	1,417.00	63.00
						10 Lbs.
24"	48"	207	Paint	1,402.00	1,423.00	59.00
	minumum height is 44"		Galv	1,491.00	1,514.00	63.00
						10 Lbs.
30"	60"	390	Paint	2,310.00	2,344.00	75.00
	minumum height is 54"		Galv	2,382.00	2,417.00	79.00
						12 Lbs.
36"	72"	522	Paint	2,732.00	2,772.00	75.00
	minumum height is 62"		Galv	2,817.00	2,858.00	79.00
						16 Lbs.
42"	84"	690	Paint	4,756.00	4,827.00	99.00
	minumum height is 84"		Galv	4,903.00	4,976.00	105.00
						16 Lbs.
48"	96"	940	Paint	6,230.00	6,322.00	99.00
	minumum height is 90"		Galv	6,424.00	6,519.00	105.00
						16 Lbs.
54"	108"	1390	Paint	9,295.00	9,432.00	134.00
	minumum height is 100"		Galv	9,584.00	9,727.00	142.00
						20 lbs.
60"	108"	1995	Paint	11,296.00	11,465.00	139.00
	minumum height is 102"		Galv	11,648.00	11,821.00	147.00
						20 lbs.
72"	132"	3760	Paint	19,392.00	19,682.00	149.00
	minumum height is 122"		Galv	19,995.00	20,294.00	158.00
						20 lbs.



## OPTIONS FOR MODEL C-10 RED TOP® CANAL GATE

<b>ADD FOR THE FOLLOWING:</b>	<b>6"</b>	<b>8"</b>	<b>10"</b>	<b>12"</b>	<b>14"</b>
CIP FRAME (for pip & sch 40 pvc)	179.00 40006159	179.00 40008159	210.00 40010159	263.00 40012159	N/A
TYPE 4 SPIGOT (for low head pip)	87.00 40006153	91.00 40008153	122.00 40010153	141.00 40012153	N/A
TAPER SETTING COLLAR (C-10C) add to flatback only(for concrete pipe)	62.00 47806154	62.00 47808154	65.00 47810154	65.00 47812154	77.00 47814154
CL-10 (FLAT SQ. BOTTOM SLIDE)	76.00	76.00	82.00	88.00	95.00
GALV. ANCHOR BOLTS (SET OF 4)	48.00 75005100-80	48.00 75005100-80	48.00 75005100-80	48.00 75005100-80	48.00 75005100-80
S.S. ANCHOR BOLTS (SET OF 4)	56.00 75005080-9A	56.00 75005080-9A	56.00 75005080-9A	56.00 75005080-9A	56.00 75005080-9A
LIMIT NUT (STD.) GALVANIZED (3 TPI RIGHT HAND)	16.00 710820731	16.00 710820731	16.00 710820731	16.00 710820731	16.00 710820731
TAMPER PROOF LIMIT NUT (GALV) RTPI, RH (LH AND 3TPI AVAILABLE)	32.00 71082842	32.00 71082842	32.00 71082842	32.00 71082842	32.00 71082842
NRE BRACKETS (PR)	51.00 54201001	51.00 54201001	51.00 54201001	51.00 54201001	51.00 54201001
NRE THREADED BRACKETS (PR)	68.00	68.00	68.00	68.00	68.00
NRE PIPE INSTALLED (PER FT.)	26.00 54201002	26.00 54201002	26.00 54201002	26.00 54201002	26.00 54201002
NON-RISING STEM ADAPTION (CL-10 COVER ONLY)	120.00	120.00	120.00	120.00	120.00
RSE BRACKETS (PR)	101.00 54209001	101.00 54209001	101.00 54209001	101.00 54209001	101.00 54209001
RSE PIPE & STEM INSTALLED (PER FT.)	31.00	31.00	31.00	31.00	31.00
TOTAL ASTM-A-I23 GALV. (ADD TO GALV. FRAME PRICE)	400.00	400.00	400.00	400.00	400.00
MACHINED FLATBACK FRAMES TO FIT O.D. STEEL PIPE	135.00	135.00	135.00	135.00	135.00
BRONZE SEATS	421.00	421.00	476.00	572.00	686.00
HDPE FLANGE ADAPTER (for HDPE & SDR35)	105.00 15006100	117.00 15008100	136.00 15010100	149.00 15012100	152.00 15014100

NOTE: SPECIAL PAINT & SPECIAL MATERIALS - POA

Specify Corrugated Metal, Concrete, PVC type or HDPE when ordering with adapter.

Type 4 is designed for PIP 63. Other sizes can be quoted upon request, please specify size required.

When ordering Limit Nuts please state whether Left Hand or Right Hand



## OPTIONS FOR MODEL C-10 RED TOP® CANAL GATE

CONTINUED

<b>ADD FOR THE FOLLOWING:</b>	<b>15"</b>	<b>16"</b>	<b>18"</b>	<b>20"</b>
CIP FRAME (for pip & sch 40 pvc)	N/A	N/A	N/A	N/A
TYPE 4 SPIGOT (for lowhead pip)	251.00 40015153	N/A	298.00 40018153	N/A
TAPER SETTING COLLAR (C-10C) add to flatback only(for concrete pipe)	77.00 47815154	77.00 47816154	89.00 47818154	N/A
CL-10 (FLAT SQ. BOTTOM SLIDE)	97.00	114.00	166.00	N/A
GALV. ANCHOR BOLTS (SET OF 4)	49.00 75005412	63.00 75006412	63.00 75006412	63.00 75006412
S.S. ANCHOR BOLTS (SET OF 4)	69.00 75005212	69.00 75006212	69.00 75006212	69.00 75006212
LIMIT NUT (STD.) GALVANIZED (710820731 - 3TPI RH, 710820821 - 4TPI RH)	16.00 710820731	16.00 710820731	21.00 710820821	21.00 710820821
TAMPER PROOF LIMIT NUT (GALV) 4TPI, RH (LH AND 3TPI AVAILABLE)	32.00 71082842	32.00 71082842	37.00 71082844	37.00 71082844
NRE BRACKETS (PR)	51.00 54201001	51.00 54201001	54.00 54202001	54.00 54202001
NRE THREADED BRACKETS (PR)	68.00	75.00	75.00	75.00
NRE PIPE INSTALLED (PER FT.)	26.00 54201002	26.00 54201002	26.00 54201002	26.00 54201002
NON-RISING STEM ADAPTION (CL-10 COVER ONLY)	120.00	120.00	120.00	N/A
RSE BRACKETS (PR)	101.00 54209001	101.00 54209001	120.00 54210001	120.00 54210001
RSE PIPE & STEM INSTALLED (PER FT.)	31.00	31.00	31.00	31.00
TOTAL ASTM-A-I23 GALV. (ADD TO GALV. FRAME PRICE)	400.00	400.00	400.00	400.00
MACHINED FLATBACK FRAMES TO FIT O.D. STEEL PIPE	135.00	135.00	135.00	135.00
BRONZE SEATS	754.00	781.00	830.00	971.00
HDPE FLANGE ADAPTER (for HDPE & SDR35)	164.00 15015100	184.00 15016100	204.00 15018100	315.00 15020100

NOTE: SPECIAL PAINT & SPECIAL MATERIALS - POA

Specify Corrugated Metal, Concrete, PVC type or HDPE when ordering with adapter.

Type 4 is designed for PIP 63. Other sizes can be quoted upon request, please specify size required.

When ordering Limit Nuts please state whether Left Hand or Right Hand



## OPTIONS FOR MODEL C-10 RED TOP® CANAL GATE

CONTINUED

<b>ADD FOR THE FOLLOWING:</b>	<b>21"</b>	<b>24"</b>	<b>30"</b>	<b>36"</b>	<b>42"</b>
TYPE 4 SPIGOT (for low head pip)	N/A	N/A	N/A	N/A	N/A
TAPER SETTING COLLAR (C10C) (for concrete pipe)	89.00 47821154	100.00 47824154	150.00 47830154	195.00 47836154	285.00 47842154
CL10 (FLAT SQ. BOTTOM SLIDE)	NA	280.00	378.00	478.00	783.00
GALV. ANCHOR BOLTS (SET OF 4)	63.00 75006412	63.00 75006412	83.00 75007412	83.00 75007412	108.00 75007416
S.S. ANCHOR BOLTS (SET OF 4)	218.00 75006112	218.00 75006112	356.00 75007112	356.00 75007112	399.00 75007116
LIMIT NUT (STD.) GALVANIZED (710820821, 710821721 - 4TPI RH, 710821131 - 3TPI LH)	21.00 710820821	21.00 710820821	32.00 710821131	32.00 710821131	37.00 710821721
TAMPER PROOF LIMIT NUT (GALV) RTPI, RH (LH AND 3TPI AVAILIBLE)	37.00 71082844	37.00 71082844	42.00 71082848	42.00 71082848	53.00 710828412
NRE BRACKETS (PR)	54.00 54202001	54.00 54202001	60.00 54203001	60.00 54203001	60.00 54204001
NRE THREADED BRACKETS (PR)	75.00	75.00	81.00	81.00	126.00
NRE PIPE INSTALLED (PER FT.)	26.00 305000003	26.00 305000003	33.00 305000004	33.00 305000004	42.00 305000006
NONRISING STEM ADAPTION (CL10 COVER ONLY)	120.00	120.00	120.00	120.00	NA
RSE BRACKETS (PR)	120.00 54210001	120.00 54210001	139.00 54211001	139.00 54211001	214.00 54212001
RSE PIPE & STEM INSTALLED (PER FT.)	35.00	35.00	35.00	35.00	50.00
TOTAL ASTM A123 GALV. (ADD TO GALV. FRAME PRICE)	400.00	400.00	550.00	825.00	1125.00
MACHINED FLATBACK FRAMES TO FIT O.D. STEEL PIPE	165.00	165.00	190.00	210.00	265.00
BRONZE SEATS	1005.00	1190.00	1720.00	2160.00	3290.00
HDPE FLANGE ADAPTER (for HDPE & SDR35)	N/A	462.00 15024100	587.00 15030100	705.00 15036100	850.00 15042100

NOTE: SPECIAL PAINT & SPECIAL MATERIALS POA

Specify Corrugated Metal, Concrete, PVC type or HDPE when ordering with adapter.

Type 4 is designed for PIP 63. Other sizes can be quoted upon request, please specify size required.

When ordering Limit Nuts please state whether Left Hand or Right Hand



## OPTIONS FOR MODEL C-10 RED TOP® CANAL GATE

CONTINUED

<b>ADD FOR THE FOLLOWING:</b>	<b>48"</b>	<b>54"</b>	<b>60"</b>	<b>72"</b>
TAPER SETTING COLLAR (C10C) (for concrete pipe)	349.00 47848154	N/A	N/A	N/A
CL10 (FLAT SQ. BOTTOM SLIDE)	N/A	N/A	N/A	N/A
GALV. ANCHOR BOLTS (SET OF 4)	108.00 75007416	121.00 75010416	121.00 75010416	121.00 75010416
S.S. ANCHOR BOLTS (SET OF 4)	399.00 75007116	399.00 75010116	399.00 75010116	399.00 75010116
LIMIT NUT (STD.) GALVANIZED (710821721 - 4TPI RH, 10821911 - 4TPI LH)	37.00 710821721	63.00 10821911	63.00 10821911	63.00 10821911
TAMPER PROOF LIMIT NUT (GALV) 4TPI, RH (LH AND 3TPI AVAILABLE)	53.00 710828412	70.00	70.00	70.00
NRE BRACKETS (PR)	60.00 54204001	60.00 54204001	60.00 54204001	N/A
NRE THREADED BRACKETS (PR)	126.00	186.00	186.00	186.00
NRE PIPE INSTALLED (PER FT.)	45.00	60.00	60.00	60.00
NONRISING STEM ADAPTION (CL10 COVER ONLY)	N/A	N/A	N/A	N/A
RSE BRACKETS (PR)	214.00 54212001	N/A	N/A	N/A
RSE PIPE & STEM INSTALLED (PER FT.)	45.00	N/A	N/A	N/A
TOTAL ASTM A123 GALV. (ADD TO GALV. FRAME PRICE)	1625.00	2350.00	3250.00	3975.00
MACHINED FLATBACK FRAMES TO FIT O.D. STEEL PIPE	300.00	N/A	N/A	N/A
BRONZE SEATS	4180.00	5725.00	6553.00	9490.00
HDPE FLANGE ADAPTER	945.00 15048100	P.O.A.	P.O.A.	P.O.A.

NOTE: SPECIAL PAINT & SPECIAL MATERIALS POA

Specify Corrugated Metal, Concrete, PVC type or HDPE when ordering with adapter.

When ordering Limit Nuts please state whether Left Hand or Right Hand

**PARTS FOR MODEL C-10 RED TOP® CANAL GATE**

CONTINUED

PART	6"	8"	10"	12"	14"
FRAME RING	134.00	137.00	153.00	160.00	197.00
FLATBACK	40006150	40008150	40010150	40012150	40014150
FRAME RING	139.00	150.00	158.00	167.00	201.00
SPIGOTBACK	40006152	40008152	40010152	40012152	40014151
COVER (SLIDE)	101.00	118.00	144.00	194.00	208.00
	41006150	41008150	41010150	41012150	41014150
LEFT WEDGE	26.00	26.00	26.00	26.00	26.00
	46206150	46206150	46206150	46206150	46206150
RIGHT WEDGE	26.00	26.00	26.00	26.00	26.00
	46306150	46306150	46306150	46306150	46306150
TOP RAIL (PAINTED) **	41.00	41.00	52.00	52.00	57.00
	47606024	47608024	47610024	47612024	47614024
THRUST COLLAR	18.00	18.00	18.00	18.00	18.00
Lift collar	48000005	48000005	48000005	48000005	48000005
COLLAR BOLTS WITH NUT (EA)	5.00 2042	5.00 2042	5.00 2042	5.00 2042	5.00 2042
BRONZE LIFT NUT	50.00	50.00	50.00	50.00	50.00
3TPI-RH	4840523111	4840523111	4840523111	4840523111	4840523111
4TPI-RH	484052312	484052312	484052312	484052312	484052312
4TPI-LH	484052313	484052313	484052313	484052313	484052313
HANDWHEEL	61.00	61.00	61.00	61.00	61.00
	49510131	49510131	49510131	49510131	49510131
WEDGE BOLTS (EA)	14.00	14.00	14.00	14.00	14.00
	80001000	80001000	80001000	80001000	80001000
ASSY BOLTS (EA)	4.00	4.00	4.00	4.00	4.00
	80800100	80800100	80800100	80800100	80800100
UHMW WASHERS (EA)	N/A	4.00	4.00	4.00	4.00
		71024591	71024591	71024591	71024591

\*\* CONTACT FACTORY FOR GALVANIZED TOP RAIL PRICING - ENDING PART WILL BE 025. EXAMPLE: 47606025

CALL FACTORY FOR STEM AND SIDE RAIL PRICING.



## PARTS FOR MODEL C-10 RED TOP® CANAL GATE

CONTINUED

PART	15"	16"	18"	20"	21"	24"
FRAME RING	200.00	270.00	297.00	444.00	475.00	581.00
FLATBACK	40015150	40016150	40018150	40020150	40021150	40024150
FRAME RING	206.00	279.00	305.00	454.00	491.00	602.00
SPIGOTBACK	40015152	40016152	40018152	40020152	40021152	40024152
COVER (SLIDE)	213.00	279.00	360.00	460.00	495.00	619.00
	41015150	41016150	41018150	41020150	41021150	41024150
LEFT WEDGE	26.00	30.00	30.00	30.00	30.00	30.00
	46206150	46216150	46216150	46216150	46216150	46216150
RIGHT WEDGE	26.00	30.00	30.00	30.00	30.00	30.00
	46306150	46316150	46316150	46316150	46316150	46316150
TOP RAIL (PAINTED) **	57.00	66.00	68.00	69.00	76.00	87.00
	47615024	47616024	47618024	47620024	47621024	47624024
THRUST COLLAR (LIFT COLLAR)	18.00	18.00	20.00	20.00	20.00	20.00
	48000005	48000005	48000010	48000010	48000010	48000010
COLLAR BOLTS WITH NUT(EA.)	5.00	5.00	5.00	5.00	5.00	5.00
	2042	2042	2042	2042	2042	2042
BRONZE LIFT NUT	50.00	50.00	70.00	70.00	70.00	70.00
3TPI-RH	4840523111	4840523111	484103311	484103311	484103311	484103311
4TPI-RH	484052312	484052312	484103312	484103312	484103312	484103312
4TPI-LH	484052313	484052313	484103313	484103313	484103313	484103313
HANDWHEEL	61.00	61.00	79.00	79.00	79.00	79.00
	49510131	49510131	49512153	49512153	49512153	49512153
WEDGE BOLTS (EA)	14.00	14.00	14.00	14.00	14.00	14.00
	80001000	80001001	80001001	80001001	80001001	80001001
ASSY BOLTS (EA)	4.00	4.00	4.00	4.00	4.00	4.00
	80800100	80800100	80800100	80800100	80800100	80800100
UHMW WASHERS (EA)	4.00	4.00	4.00	4.00	4.00	4.00
	71024591	71024591	71024592	71024592	71024592	71024592

\*\* CONTACT FACTORY FOR GALVANIZED TOP RAIL PRICING - ENDING PART WILL BE 025. EXAMPLE: 47615025  
CALL FACTORY FOR STEM AND SIDE RAIL PRICING.

**PARTS FOR MODEL C-10 RED® TOP CANAL GATE**  
 CONTINUED

PART	30"	36"	42"	48"	54"	60"	72"
FRAME RING	1,063.00	1,131.00	2,404.00	2,721.00	4,935.00	5,336.00	6,357.00
FLATBACK	40030150	40036150	40042150	40048150	40054150	40060150	40072150
FRAME RING	1,097.00	1,173.00	2,489.00	2,819.00	5,072.00	5,526.00	8,252.00
SPIGOTBACK	40030152	40036152	40042152	40048152	40054152	40060152	40072152
COVER (SLIDE)	1,053.00	1,354.00	2,496.00	3,257.00	5,983.00	7,165.00	7,750.00
	41030150	41036150	41042150	41048150	41054150	41060150	41072150
LEFT WEDGE	63.00	63.00	63.00	63.00	132.00	132.00	142.00
	46230150	46230150	46230150	46230150	46254150	46254150	46272150
RIGHT WEDGE	63.00	63.00	63.00	63.00	132.00	132.00	142.00
	46330150	46330150	46330150	46330150	46354150	46354150	46372150
TOP RAIL (PAINTED) ***	108.00	126.00	210.00	239.00	246.00	270.00	326.00
	47630024	47636024	47642024	47648024	47654024	47660024	47672024
THRUST COLLAR	28.00	28.00	72.00	See below	See below	See below	NA
Lift collar	48000015	48000015	48000020				
COLLAR BOLTS (EA)	5.00	5.00	6.00	6.00	6.00	6.00	NA
with nut	2049	2049	2063	2063	2063	2063	
BRONZE LIFT NUT	77.00	77.00	184.00	184.00	184.00	184.00	NA
3TPI-RH	484154311	484154311					
4TPI-RH	484154312	484154312	4842054161	4842054161	484205418	484205418	
4TPI-LH	484154313	484154313					
HANDWHEEL	90.00	90.00	156.00	192.00	395.00	395.00	NA
	49515181	49515181	49518250	49524243	49530243	49530243	
WEDGE BOLTS (EA)	14.00	14.00	17.00	17.00	17.00	17.00	17.00
	80001002	80001002	1264	1264	1264	1264	1264
ASSY BOLTS (EA)	6.00	6.00	6.00	6.00	6.00	6.00	6.00
	80801100	80801100	80801100	80801100	80801100	80801100	80801100
LIFT HSG, TY-2, MACH (does not include base)	NA	NA	NA	102.00	102.00	102.00	NA
				48000030	48000030	48000030	
THRUST BEARING(EA)	NA	NA	NA	75.00	75.00	75.00	NA
2 per pkg.				84501037	84501037	84501037	
UHMW WASHERS(EA)	4.00	4.00	4.00	4.00	4.00	4.00	4.00
Part in is	71024593	71024593	71024592	71024592	71024592	71024592	71024592

\*\*\* CONTACT FACTORY FOR GALVANIZED TOP RAIL PRICING - ENDING PART WILL BE 025. EXAMPLE: 47630025

FOR 48" TO 60" LIFT COLLARS SEE LIFT HSG, TY2, MACH

CALL FACTORY FOR STEM AND SIDE RAIL PRICING.



## ANNULAR CORRUGATED STEEL PIPE STUBS AND ATTACHING FEES

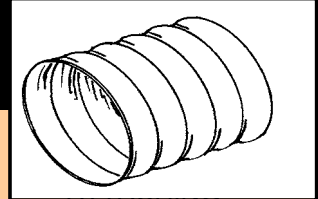

PIPE SIZE (IN.)	GAUGE	CORRUGATED STEEL PIPE		ASPHALT DIPPED PIPE		INSTALLATION CHARGE
		1-FOOT	2-FOOT	1-FOOT	2-FOOT	
8	16	24.00	47.00	29.00	58.00	89.00
10	16	30.00	60.00	39.00	78.00	95.00
12	16	43.00	85.00	54.00	108.00	96.00
14	16	48.00	96.00	66.00	131.00	105.00
15	16	54.00	107.00	67.00	134.00	110.00
16	16	55.00	109.00	69.00	137.00	115.00
18	16	57.00	114.00	77.00	155.00	115.00
20	16	63.00	124.00	88.00	158.00	123.00
21	14	63.00	124.00	88.00	158.00	126.00
24	14	82.00	162.00	111.00	221.00	147.00
30	14	98.00	194.00	128.00	266.00	180.00
36	12	119.00	240.00	161.00	321.00	212.00
42	12	140.00	276.00	186.00	371.00	276.00
48	12	165.00	329.00	226.00	443.00	317.00
54	12	POA	POA	POA	POA	POA
60	10	POA	POA	POA	POA	POA
72	10	POA	POA	POA	POA	POA

PRICES DO NOT INCLUDE COUPLER. COUPLER AT PRICE OF 1-FOOT STUB.



## MODEL FC-10 COMBINATION DRAINAGE AND CANAL GATES

WITH FLATBACK FRAME / SPIGOT BACK FRAME

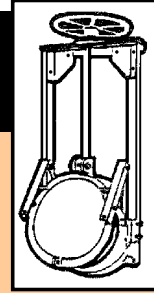

**PRICE INCLUDES :**

SELFCONTAINED FRAME

BRASS LIFT NUT

HANDWHEEL LIFT

GALVANIZED FASTENERS

STANDARD SHOPCOAT PAINT

GALVANIZED HINGE ARMS

Gate Size	Min. Frame Height	Weight	Material	Flat Back	Spigot Back	Each Add'l. Foot
16"	48"	190	Paint	2,526.00 09216048	2,601.00 9416048	45.00 10 Lbs.
			Galv	2,660.00 09216049	2,740.00 9416049	48.00 10 Lbs.
18"	48"	220	Paint	2,569.00 9218048	2,646.00 9418048	59.00 10 Lbs.
			Galv	2,811.00 09218049	2,896.00 9418049	63.00 10 Lbs.
24"	60"	303	Paint	3,498.00 9224060	3,602.00 9424060	59.00 11 Lbs.
			Galv	3,683.00 09224061	3,793.00 9424061	63.00 11 Lbs.
30"	72"	509	Paint	4,837.00 09230072	4,983.00 9430072	75.00 18 Lbs.
			Galv	5,091.00 09230073	5,243.00 9430073	79.00 18 Lbs.
36"	84"	655	Paint	7,083.00 09236084	7,296.00 9436084	75.00 21 Lbs.
			Galv	7,346.00 09236085	7,566.00 9436085	79.00 21 Lbs.
42"	96"	885	Paint	12,110.00 09242096	12,473.00 9442096	99.00 30 Lbs.
			Galv	12,742.00 09242097	13,125.00 9442097	105.00 30 Lbs.
48"	120"	1150	Paint	17,446.00 09248120	17,969.00 9448120	99.00 30 Lbs.
			Galv	18,358.00 09248121	18,906.00 9448121	105.00 30 Lbs.
60"	144"	2929	Paint	33,348.00 09260144	34,348.00 9460144	139.00 36 Lbs.
			Galv	35,096.00 09260145	36,148.00 9460145	147.00 36 Lbs.

SEE MODEL F10 PRICE LIST FOR SPECIAL LINKS, BOLTS AND BUSHINGS.

SEE MODEL C10 PRICE LIST FOR ANCHOR BOLTS.

ALL OTHER PARTS P.O.A.

FOR ORDER ENTRY ADD "7" AT BEGINNING OF NUMBER STARTING WITH "0" ZERO FOR FLATBACKS

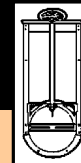
**MODEL C-20 RED TOP® CANAL GATE  
W / FLANGEBACK / SPIGOTBACK FRAME**

Gate Size	Standard Frame Height	Weight	Material	Flat Back	Spigot Back	Each Add'l. Foot
8"	24" mininum height is 24"	69	Paint	\$ 867.00	\$ 898.00	45.00
				Galv	909.00	943.00
10"	24" mininum height is 24"	76	Paint	909.00	944.00	45.00
				Galv	956.00	993.00
12"	24" mininum height is 30"	110	Paint	992.00	1,024.00	45.00
				Galv	1,042.00	1,078.00
14"	36" mininum height is 32"	118	Paint	1,205.00	1,220.00	45.00
				Galv	1,269.00	1,284.00
15"	36" mininum height is 32"	122	Paint	1,209.00	1,249.00	45.00
				Galv	1,273.00	1,313.00
16"	36" mininum height is 33"	125	Paint	1,356.00	1,453.00	45.00
				Galv	1,428.00	1,529.00
18"	36" mininum height is 36"	175	Paint	1,478.00	1,533.00	59.00
				Galv	1,556.00	1,612.00
20"	48" mininum height is 42"	210	Paint	1,771.00	1,810.00	59.00
				Galv	1,862.00	1,907.00
21"	48" mininum height is 42"	220	Paint	1,960.00	2,052.00	59.00
				Galv	2,064.00	2,159.00
24"	48" mininum height is 48"	265	Paint	2,011.00	2,074.00	59.00
				Galv	2,116.00	2,176.00
30"	60" mininum height is 60"	482	Paint	3,255.00	3,455.00	79.00
				Galv	3,404.00	3,530.00
36"	72" mininum height is 70"	669	Paint	4,530.00	4,872.00	90.00
				Galv	4,771.00	5,022.00
42"	84" mininum height is 84"	1060	Paint	8,829.00	9,897.00	132.00
				Galv	8,876.00	9,960.00
						22 Lbs.



## OPTIONS FOR MODEL C-20 RED TOP® CANAL GATE

<b>ADD FOR THE FOLLOWING:</b>	8"	10"	12"	14"	15"	16"	18"	20"
BRONZE SEATS	472.00	533.00	640.00	768.00	844.00	874.00	929.00	1,087.00
NRE THREADED BRACKETS (PR)	68.00	68.00	68.00	68.00	68.00	75.00	75.00	75.00
NRE PIPE INSTALLED (PER FT)	26.00 305000003	26.00 305000003	26.00 305000003	26.00 305000003	26.00 305000003	26.00 305000003	33.00 305000004	33.00 305000004
RSE EXTENSION BRACKETS (PR)	101.00 54209001	101.00 54209001	101.00 54209001	101.00 54209001	101.00 54209001	101.00 54209001	120.00 54210001	120.00 54210001
RSE PIPE & STEM INSTALLED (PER FT)	35.00	35.00	35.00	35.00	35.00	35.00	35.00	35.00
GALV. ANCHOR BOLTS (SET OF 6)	48.00 75005408	48.00 75005408	48.00 75005408	48.00 75005408	48.00 75005408	48.00 75005408	65.00 75006408	65.00 75006408
S.S. ANCHOR BOLTS (SET OF 6)	189.00 75005108	189.00 75005108	189.00 75005108	189.00 75005108	189.00 75005108	189.00 75005108	331.00 75006108	331.00 75006108
MACHINING BACK FOR FLANGE FRAME	60.00	60.00	60.00	60.00	80.00	80.00	100.00	100.00
MACHINING FOR OD PIPE	60.00	60.00	60.00	60.00	80.00	80.00	100.00	100.00
125 LB. FLANGE DRILLING 150 LB. drilling add \$75.00 to above pricing	90.00	90.00	90.00	90.00	90.00	90.00	90.00	90.00
TOTAL ASTM-A-123 GALV. (ADD TO GALV. FRAME PRICE)	400.00	400.00	400.00	400.00	400.00	400.00	400.00	400.00
LIMIT NUT (GALVANIZED)* (3 TPI RH) OTHERS AVAILABLE	16.00 10820731	16.00 10820731	16.00 10820731	16.00 10820731	16.00 10820731	16.00 10820731	32.00 10821131	32.00 10821131
TAMPER PROOF LIMIT NUT*	30.00	30.00	30.00	30.00	30.00	30.00	40.00	40.00
HDPE FLANGE ADAPTER	P.O.A.	P.O.A.	P.O.A.	P.O.A.	P.O.A.	P.O.A.	P.O.A.	P.O.A.

Specify Corrugated Metal, Concrete, PVC type or HDPE when ordering with adapter.

\* Note: Please specify Left Hand or Right Hand Threads when ordering Limit Nuts



**OPTIONS FOR MODEL C-20 RED TOP® CANAL GATE**  
CONTINUED

<b>ADD FOR THE FOLLOWING:</b>	<b>21"</b>	<b>24"</b>	<b>30"</b>	<b>36"</b>	<b>42"</b>
BRONZE SEATS	1,253.00	1,483.00	2,142.00	2,692.00	4,099.00
NRE THREADED EXT. BRACKETS (PR)	79.00	79.00	86.00	87.00	133.00
NRE PIPE INSTALLED (PER FT)	33.00 305000004	33.00 305000004	42.00 305000006	42.00 305000006	42.00 305000006
RSE EXTENSION BRACKETS (PR)	120.00 54210001	120.00 54210001	139.00 54211001	139.00 54211001	139.00 54211001
RSE PIPE & STEM INSTALLED (PER FT)	37.00	37.00	48.00	48.00	48.00
GALV. ANCHOR BOLTS (SET OF 6)	65.00 75006408	65.00 75006408	63.00 74007410	63.00 74007410	63.00 74007410
S.S. ANCHOR BOLTS (SET OF 6)	331.00 75006108	331.00 75006108	382.00 75007110	382.00 75007110	382.00 75007110
MACHINING BACK FOR FLANGE FRAME	158.00	158.00	217.00	217.00	309.00
MACHINING FOR O.D. PIPE	174.00	174.00	217.00	217.00	309.00
125 LB. FLANGE DRILLING 150 LB. drilling add \$75.00 to above pricing	N/A	95.00	95.00	95.00	95.00
TOTAL ASTM-A-123 GALV. (ADD TO GALV. FRAME PRICE)	400.00	542.00	788.00	1035.00	1313.00
LIMIT NUT (GALVANIZED)* (710821131 - 3TPI RH, 710821721 - 4TPI RH)	32.00 710821131	32.00 710821131	37.00 710821721	37.00 710821721	37.00 710821721
TAMPER PROOF LIMIT NUT*	42.00	42.00	42.00	42.00	42.00
HDPE FLANGE ADAPTER	P.O.A.	P.O.A.	P.O.A.	P.O.A.	P.O.A.

Specify Corrugated Metal, Concrete, PVC type or HDPE when ordering with adapter.

\* Note: Please specify Left Hand or Right Hand Threads when ordering Limit Nuts

**PARTS FOR MODEL C-20 RED TOP® CANAL GATE**

<b>PART</b>	<b>8"</b>	<b>10"</b>	<b>12"</b>	<b>14"</b>	<b>15"</b>
<b>FRAME RING FLATBACK</b>	174.00	203.00	241.00	293.00	300.00
	40008162	40010162	40012162	40014162	40015162
<b>FRAME RING SPIGOTBACK</b>	182.00	213.00	252.00	306.00	315.00
	40008164	40010164	40012164	40014164	40015164
<b>COVER (SLIDE) CAST IRON</b>	149.00	173.00	246.00	336.00	360.00
	41008162	41010162	41012162	41014162	41015162
<b>ARCH</b>	52.00	57.00	57.00	80.00	104.00
	44008162	44010162	44012162	44014162	44015162
<b>LEFT WEDGE</b>	35.00	35.00	35.00	35.00	35.00
	46201162	46201162	46201162	46201162	46201162
<b>RIGHT WEDGE</b>	35.00	35.00	35.00	35.00	35.00
	46301162	46301162	46301162	46301162	46301162
<b>TOP RAIL (PAINTED)**</b>	46.00	46.00	54.00	59.00	59.00
	47608040	47610040	47612040	47614040	47615040
<b>THRUST COLLAR Lift Collar</b>	18.00	18.00	18.00	18.00	18.00
	48000005	48000005	48000005	48000005	48000005
<b>COLLAR BOLTS (EA)</b>	5.00	5.00	5.00	5.00	5.00
	2042	2042	2042	2042	2042
<b>BRONZE LIFT NUT</b>	50.00	50.00	50.00	50.00	50.00
3TPI-RH	4840523111	4840523111	4840523111	4840523111	4840523111
4TPI-RH	484052312	484052312	484052312	484052312	484052312
4TPI-LH	484052313	484052313	484052313	484052313	484052313
<b>HANDWHEEL</b>	73.00	73.00	73.00	73.00	73.00
	49512131	49512131	49512131	49512131	49512131
<b>ARCH BOLT</b>	13.00	13.00	13.00	13.00	13.00
	1176	1176	1176	1176	1176
<b>SCREW BOLT</b>	5.00	5.00	5.00	5.00	5.00
	2043	2043	2043	2043	2043
<b>WEDGE BOLTS (EA)</b>	13.00	13.00	13.00	13.00	13.00
	1176	1176	1176	1176	1176
<b>FRAME BOLTS (EA)</b>	5.00	5.00	5.00	5.00	5.00
	2041	2041	2041	2041	2041
<b>UHMW WASHERS (EA)</b>	4.00	4.00	4.00	4.00	4.00
	71024591	71024591	71024591	71024591	71024591

\*\* CONTACT FACTORY FOR GALVANIZED TOP RAIL PRICING - ENDING PART WILL BE 041. EXAMPLE: 47608041  
CALL FACTORY FOR STEM AND SIDE RAIL PRICING.

**PARTS FOR MODEL C20 RED TOP® CANAL GATE**  
 CONTINUED

PART	16"	18"	20"	21"	24"	30"	36"	42"
FRAME RING	347.00	411.00	520.00	527.00	642.00	1118.00	1433.00	3175.00
FLATBACK	40016162	40018162	40020162	40021162	40024162	40030162	40036162	40042162
FRAME RING	364.00	433.00	545.00	554.00	674.00	1172.00	1880.00	3360.00
SPIGOTBACK	40016164	40018164	40020164	40021164	40024164	40030164	40036164	40042164
COVER (SLIDE)	372.00	436.00	533.00	540.00	677.00	1213.00	1976.00	3325.00
CAST IRON	41016162	41018162	41020162	41021162	41024162	41030162	41036162	41042162
ARCH	132.00	135.00	213.00	224.00	256.00	460.00	775.00	738.00
	44016162	44018162	44020162	44021162	44024162	44030162	44036162	44042162
LEFT WEDGE	35.00	69.00	69.00	69.00	77.00	77.00	82.00	88.00
	46201162	46202162	46202162	46202162	46203162	46203162	46204162	46205162
RIGHT WEDGE	35.00	69.00	69.00	69.00	77.00	77.00	82.00	88.00
	46301162	46302162	46302162	46302162	46303162	46303162	46304162	46305162
TOP RAIL (PAINTED)**	66.00	86.00	87.00	88.00	94.00	120.00	146.00	177.00
	47616040	47618040	47620040	47621040	47624040	47630040	47636040	47642040
THRUST COLLAR	18.00	28.00	28.00	28.00	28.00	72.00	72.00	102.00
Lift Collar	48000005	48000015	48000015	48000015	48000015	48000020	48000020	48000030
COLLAR BOLTS	5.00	5.00	5.00	5.00	5.00	6.00	6.00	6.00
(EA)	2049	2049	2049	2049	2049	2390	2390	2390
BRONZE LIFT NUT	50.00	77.00	77.00	77.00	77.00	184.00	184.00	184.00
3TPI-RH	4840523111	484154311	484154311	484154311	484154311			
4TPI-RH	484052312	484154312	484154312	484154312	484154312	4842054161	4842054161	4842054161
4TPI-LH	484052313	484154313	484154313	484154313	484154313			
HANDWHEEL	73.00	90.00	90.00	90.00	90.00	156.00	156.00	192.00
	49512131	49515181	49515181	49515181	49515181	49518250	49518250	49524243
ARCH BOLT	13.00	13.00	13.00	13.00	13.00	15.00	15.00	15.00
	1176	1176	1176	2370	2370			
SCREW BOLT	13.00	13.00	13.00	13.00	13.00	15.00	15.00	15.00
	1176	2051	2051	2051	2051			
WEDGE BOLTS	13.00	13.00	13.00	13.00	13.00	13.00	13.00	19.00
(EA)	1176	2054	2054	2054	2054	2069	2069	
FRAME BOLTS	5.00	5.00	5.00	5.00	5.00	5.00	5.00	6.00
(EA)	2049	2049	2049	2049	2049	2049	2049	2063
THRUST BEARING	N/A	N/A	N/A	N/A	N/A	N/A	N/A	66.00
(EA)								
UHMW WASHERS	4.00	4.00	4.00	4.00	4.00	4.00	4.00	
(EA)	71024591	71024593	71024593	71024593	71024593	71024594	71024594	

\*\* CONTACT FACTORY FOR GALVANIZED TOP RAIL PRICING - ENDING PART WILL BE 041. EXAMPLE: 47608041  
 CALL FACTORY FOR STEM AND SIDE RAIL PRICING.



## MODEL P-30 RED TOP® PRESSURE GATE

Model P-30 is special order

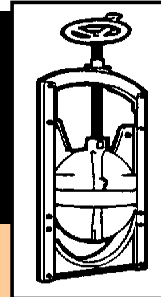

P-30-1				P-30-C FLATBACK WITH TAPER SETTING COLLAR*			
SIZE	WT. (lbs.)	W/IRON SEATS	W/BRZ SEATS [1]	WT. (lbs.)	W/IRON SEATS	W/BRZ SEATS [1]	
6"	105	Special Order 13406001	Special Order 13406002	105	Special Order 13406010	Special Order 13406020	
8"	120	Special Order 13408001	Special Order 13408002	120	Special Order 13408010	Special Order 13408020	
10"	165	Special Order 13410001	Special Order 13410002	165	Special Order 13410010	Special Order 13410020	
12"	185	Special Order 13412001	Special Order 13412002	185	Special Order 13412010	Special Order 13412020	
14"	295	Special Order 13414001	Special Order 13414002	295	Special Order 13414010	Special Order 13414020	
16"	400	Special Order 13416001	Special Order 13416002	400	Special Order 13416010	Special Order 13416020	
18"	475	Special Order 13418001	Special Order 13418002	475	Special Order 13418010	Special Order 13418020	
20"	525	Special Order 13420001	Special Order 13420002	525	Special Order 13420010	Special Order 13420020	
24"	590	Special Order 13424001	Special Order 13424002	590	Special Order 13424010	Special Order 13424020	

6" thru 14" valves come with Iron Rails. 16" and above come standard with galvanized steel rails unless otherwise noted.

Specify type and size of pipe when ordering adaption.

\* Please note that the P-30-C includes a galvanized sheet metal collar for installation into pipe.

Note that 304ss stems are available upon request from the factory

Call factory for price and lead time.

**PARTS FOR MODEL P-30 RED TOP® PRESSURE GATE**

PART	6"	8"	10"	12"	14"	16"	18"	20"	24"
FLATBACK									
FRAME	\$410.00	\$420.00	\$482.00	\$564.00	\$ 865.00	\$1,130.00	\$1,226.00	\$1,400.00	\$1,985.00
(IRON SEAT)	40006134	40008134	40010134	40012134	40014134	40016134	40018134	40020134	40024134
FLATBACK									
FRAME	655.00	663.00	755.00	843.00	1,208.00	1,335.00	1,575.00	2,000.00	2,478.00
(BRZ SEAT)	40206134	40208134	40210134	40212134	40214134	40216134	40218134	40220134	40224134
HEADPIECE						150.00	237.00	338.00	338.00
(Yoke)						47616134	47618134	47620134	47624134
COVER	184.00	195.00	200.00	205.00	216.00	229.00	305.00	552.00	870.00
(IRON SEAT)	41006050	41008050	41010050	41012050	41014050	41016050	41018050	41020050	41024050
COVER	279.00	296.00	299.00	333.00	482.00	603.00	743.00	1,223.00	1,851.00
(BRZ SEAT)	41006051	41408051	41410051	41412051	41414051	41416051	41418051	41420051	41424051
ARCH	44.00	50.00	67.00	134.00	71.00	162.00	186.00	196.00	224.00
	44006102	44008102	44010102	44012102	44014102	44016102	44018102	44020102	44024102
BRASS	115.00	116.00	120.00	125.00	135.00	180.00	194.00	271.00	329.00
SCREW	42406134	42408134	42410134	42412134	42414134	42416134	42418134	42420134	42424134
W/HEAD Head= ext. brkt									
BRASS	37.00	37.00	37.00	37.00	37.00	58.00	58.00	97.00	122.00
SCREW	42106102	42106102	42106102	42106102	42106102	42116102	42116102	42120102	42124102
NUT Thrust nut									
SCREW	20.00	20.00	20.00	20.00	20.00	24.00	26.00	30.00	131.00
HEAD	42306134	42306134	42306134	42306134	42306134	43616134	42314134	42320134	42324134
W/PIN									
LEFT RAIL	27.00	27.00	27.00	32.00	55.00	N/A	N/A	N/A	N/A
(IRON)	47406134	47408134	47410134	47412134	47414134				
RIGHT RAIL	27.00	27.00	27.00	32.00	55.00	N/A	N/A	N/A	N/A
(IRON)	47506134	47508134	47510134	47512134	47514134				
LEFT RAIL	N/A	N/A	N/A	N/A	N/A	53.00	60.00	75.00	97.00
(STEEL)						47416234	47418234	47420234	47424234
RIGHT RAIL	N/A	N/A	N/A	N/A	N/A	53.00	60.00	75.00	97.00
(STEEL)						47516234	47518234	47520234	47524234
LEFT RAIL	N/A	N/A	N/A	N/A	N/A	79.00	99.00	116.00	153.00
(STAINLESS STEEL)						47416334	47418334	47420334	47424334
RIGHT RAIL	N/A	N/A	N/A	N/A	N/A	79.00	99.00	116.00	153.00
(STAINLESS STEEL)						47516334	47518334	47520334	47524334
THRUST	38.00	38.00	38.00	38.00	38.00	48.00	48.00	48.00	58.00
COLLAR	48006134	48006134	48006134	48006134	48006134	48014134	48014134	48020134	48024134
COLLAR	4.00	4.00	4.00	4.00	5.00	5.00	5.00	7.00	7.00
BOLTS	2238	2238	2238	2238	2300	2300	2300	2306	2306
TEE HANDLE	25.00	25.00	25.00	25.00	25.00	N/A	N/A	N/A	N/A
	50006134	50006134	50006134	50006134	50006134				
HANDWHEEL						63.00	82.00	82.00	215.00
						49512076	49515076	49515088	49518126
ASSY BOLTS	4.00	4.00	4.00	4.00	4.00	6.00	6.00	6.00	6.00
(EA)	1235	1235	1235	1235	1235	1231	1231	1231	1231
SET SCREWS	3.00	3.00	3.00	3.00	3.00	3.00	3.00	3.00	3.00
(EA)	2860	2860	2860	2860	2860	2860	2860	2860	2860



## MODEL AC-31 ALUMINUM CANAL SLIDE GATE

SPIGOT BACK OR FLATBACK [1]

SELFCONTAINED FRAME, STEM AND LIFT

(LIFTS SIZED FOR 10 FT. HEAD) [3]

AC-31 Canal Gates are special order

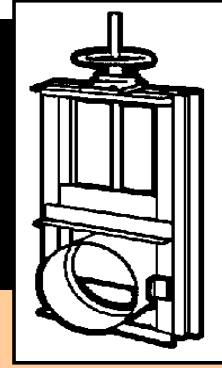

SIZE	MIN. "H" (INCHES)	SPIGOTBACK		FLATBACK		ADD FOR		
		WT. (lbs.)	PRICE	WT. (lbs.)	PRICE	EACH FOOT (lbs.)	PRICE (PER FOOT)	T304SS ANCHOR BOLTS[2]
12"	22	79	Call 18012022	97	Call 18212022	9	Call	Call
15"	29	86	Call 18015029	105	Call 18215029	9	Call	Call
18"	34	103	Call 18018034	123	Call 18218034	10	Call	Call
21"	37	125	Call 18021037	147	Call 18221037	10	Call	Call
24"	43	151	Call 18024043	177	Call 18224043	10	Call	Call
30"	55	260	Call 18030055	290	Call 18230055	12	Call	Call
36"	64	390	Call 18036064	427	Call 18236064	12	Call	Call
42"	73	536	Call 18042073	575	Call 18242073	13	Call	Call
48"	84	742	Call 18048084	794	Call 18248084	13	Call	Call
54"	96	995	Call 18054096	1050	Call 18254096	13	Call	Call
60"	105	1360	Call 18060105	1420	Call 18260105	13	Call	Call
72"	128	2442	Call 18072128	2510	Call 18272128	16	Call	Call
84"	148	3095	Call 18084148	3167	Call 18284148	20	Call	Call

[1] Also available with Machined Flangeback and 25lb or 125lb ANSI Drilling POA

[2] One Set of Anchor Bolts for minimum frame gate POA for longer frame heights

Special NonSelf contained units available for use with Extension Stems and Pedestal Lifts POA

Special Diameters available POA

Specify Corrugated Metal, Concrete, PVC type or HDPE when ordering with adapter. Inside diameter of pipe is required when ordering

[3] Lifts can be sized for over 10 ft head, please specify head or pressure when requesting a quotation.

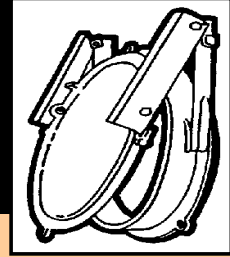
**MODEL F-10 RED TOP® CAST IRON DRAINAGE GATE  
(FLATBACK OR SPIGOTBACK)**

SIZE	WT. (lbs.)	mount to wall FLATBACK	WT. (lbs.)	CMP SPIGOTBACK	WT. (lbs.)	Concrete FLATBACK W / TAPER SETTING COLLAR	HDPE ADAPTER	
4"	9	305.00 07404001		305.00 07604001		N/A	N/A	
6"	11	336.00 07406001		349.00 07606001		399.00 07406010	105.00 15006100	
8"	23	368.00 07408001		375.00 07608001		483.00 07408010	117.00 15008100	
10"	43	441.00 07410001		455.00 07610001		494.00 07410010	136.00 15010100	
12"	50	473.00 07412001		485.00 07612001		504.00 07412010	149.00 15012100	
14"	55	588.00 07414001		609.00 07614001		636.00 07414010	152.00 15014100	
15"	59	604.00 07415001		620.00 07615001		657.00 07415010	164.00 15015100	
16"	75	662.00 07416001		678.00 07616001		714.00 07416010	184.00 15016100	
18"	93	930.00 07418001		961.00 07618001		982.00 07418010	204.00 15018100	
20"	110	998.00 07420001		1,029.00 07620001		1,071.00 07420010	315.00 15020100	
21"	115	1,029.00 07421001		1,052.00 07621001		1,087.00 07421010	415.00 15021100	
24"	155	1,339.00 07424001		1,472.00 07624001		1,523.00 07424010	462.00 15024100	
30"	300	2,022.00 07430001		2,090.00 07630001		2,100.00 07430010	587.00 15030100	
36"	430	2,400.00 07436001		2,431.00 07636001		2,520.00 07436010	705.00 15036100	
42"	565	4,536.00 07442001		4,736.00 07642001		4,778.00 07442010	893.00 15042100	
48"	720	5,697.00 07448001		6,048.00 07648001		6,090.00 07448010	945.00 15048100	
54"	1135	7,765.00 07454001		8,133.00 07654001		#N/A	POA 15054100	
60"	1900	9,015.00 07460001		10,469.00 07660001		#N/A	POA 15060100	
72"	2480	Call Factory 07472001		Call Factory 07672001		N/A	POA 15072100	
<b>ADD FOR:</b>								
MACHINED FLATBACK FRAMES TO FIT O.D. STEEL PIPE				6" 16"	18" 20"	21" 24"	30" 36"	42" 48"
				149.00	160.00	189.00	217.00	311.00

Call factory for 100% total galvanized pricing.

Note: CMP is for Corrugated Metal Pipe.

Specify Corrugated Metal, Concrete, PVC type or HDPE when ordering with adapter. Inside diameter of pipe is required when ordering

**OPTIONS FOR MODEL F-10 RED TOP® CAST IRON DRAINAGE GATE**

SIZE	GALVANIZED ANCHOR BOLTS	STAINLESS ANCHOR BOLTS	BRASS LINKS	STAINLESS LINKS	HEAVY DUTY LINKS	STAINLESS OR BRONZE HINGE BOLTS	BRONZE SEATS
4"	48.00 75005408	189.00 75005108	54.00	33.00	276.00	49.00	542.00
6"	48.00 75005408	189.00 75005108	54.00	35.00	293.00	52.00	542.00
8"	48.00 75005408	189.00 75005108	61.00	35.00	293.00	52.00	542.00
10"	48.00 75005408	189.00 75005108	61.00	43.00	332.00	52.00	613.00
12"	48.00 75005408	189.00 75005108	70.00	46.00	332.00	52.00	737.00
14"	48.00 75005408	189.00 75005108	80.00	55.00	332.00	52.00	883.00
15"	48.00 75005408	189.00 75005108	80.00	58.00	332.00	57.00	971.00
16"	48.00 75005408	189.00 75005108	105.00	73.00	385.00	57.00	1005.00
18"	48.00 75006410	277.00 75006110	167.00	113.00	408.00	134.00	1067.00
20"	48.00 75006410	277.00 75006110	231.00	123.00	434.00	134.00	1250.00
21"	48.00 75006410	277.00 75006110	242.00	164.00	434.00	134.00	1372.00
24"	48.00 75006410	277.00 75006110	257.00	279.00	475.00	134.00	1623.00
30"	83.00 75007412	356.00 75007112	407.00	305.00	611.00	249.00	2347.00
36"	83.00 75007412	356.00 75007112	487.00	346.00	706.00	249.00	2948.00
42"	83.00 75007412	356.00 75007112	N/A	480.00	1035.00	280.00	4488.00
48"	83.00 75007412	356.00 75007112	N/A	557.00	1199.00	317.00	5709.00
54"	173.00 75010414	399.00 75010114	N/A	Call Factory	N/A	317.00	7817.00
60"	173.00 75010414	399.00 75010114	N/A	Call Factory	N/A	371.00	8919.00
72"	173.00 75010414	399.00 75010114	N/A	Call Factory	N/A	371.00	12959.00

**PARTS FOR MODEL F-10 RED TOP® CAST IRON DRAINAGE GATE**

SIZE	FLATBACK FRAME	SPIGOTBACK FRAME	COVER (FLAP)	HINGE LINK (GALV) LEFT	HINGE LINK (GALV) RIGHT	BRONZE BUSHING	GALV. BUSHING	GALV HINGE BOLTS & NUT (EA)	TAPER SETTING COLLAR
4"	198.00 40004074	204.00 40004076	153.00 41004074	19.00 45304075	19.00 45404075	7.00 83504162	NA	4.00 1263	N/A
6"	201.00 40006074	205.00 40006076	156.00 41006074	19.00 45306075	19.00 45406075	7.00 83504162	NA	4.00 1263	62.00 47806154
8"	215.00 40008074	218.00 40008076	168.00 41008074	24.00 45308075	24.00 45408075	7.00 83504162	NA	4.00 1263	62.00 47808154
10"	263.00 40010074	268.00 40010076	221.00 41010074	24.00 45310075	24.00 45410075	7.00 83504162	NA	4.00 1263	65.00 47810154
12"	266.00 40012074	275.00 40012076	247.00 41012074	24.00 45312075	24.00 45412075	7.00 83504162	NA	4.00 1263	65.00 47812154
14"	277.00 40014074	289.00 40014076	258.00 41014074	26.00 45314075	26.00 45414075	7.00 83504162	NA	4.00 1263	77.00 47814154
15"	289.00 40015074	300.00 40015076	279.00 41015074	27.00 45315075	27.00 45415075	7.00 83504162	NA	4.00 1263	77.00 47815154
16"	368.00 40016074	384.00 40016076	307.00 41016074	28.00 45316075	28.00 45416075	7.00 83504162	NA	4.00 1263	77.00 47816154
18"	401.00 40018074	411.00 40018076	414.00 41018074	36.00 45318075	36.00 45418075	14.00 83507300	NA	7.00 2064	89.00 47818154
20"	478.00 40020074	498.00 40020076	431.00 41020074	42.00 45320075	42.00 45420075	14.00 83507300	NA	7.00 2064	89.00 47820154
21"	552.00 40021074	578.00 40021076	452.00 41021074	44.00 45321075	44.00 45421075	14.00 83507300	NA	7.00 2064	89.00 47821154
24"	627.00 40024074	647.00 40024076	656.00 41024074	49.00 45324075	49.00 45424075	14.00 83507300	NA	7.00 2064	100.00 47824154
30"	1218.00 40030074	1250.00 40030076	956.00 41030074	80.00 45330075	80.00 45430075	23.00 83510425	NA	16.00 2073	150.00 47830154
36"	1291.00 40036074	1418.00 40036076	1238.00 41036074	92.00 45336075	92.00 45436075	23.00 83510425	NA	16.00 2073	195.00 47836154
42"	2772.00 40042074	2811.00 40042076	2573.00 41042074	117.00 45342075	117.00 45442075	40.00 83510600	NA	16.00 2075	285.00 47842154
48"	3422.00 40048074	3518.00 40048076	3570.00 41048074	142.00 45348075	142.00 45448075	40.00 83510600	NA	16.00 2075	349.00 47848154
54"	4639.00 40054074	4799.00 40054076	4568.00 41054074	284.00 45354075	284.00 45454075	77.00 83512688	37.00 83252130	35.00 2076	N/A
60"	4925.00 40060074	5040.00 40060076	5040.00 41060074	315.00 45360075	315.00 45460075	120.00 83512662	37.00 83252130	35.00 2076	N/A
72"	6170.00 40072074	7194.00 40072076	8190.00 41072074	347.00 45372075	347.00 45472075	120.00 83512662	53.00 102230-7	35.00 2076	N/A

Note: For 304SS SS Hinge Links replace last part number digit with : "4". Example: 45304074 and 45604074 will be 304SS.

Call Factory for 304SS Hinge Link pricing.



## MODEL AF-41 ALUMINUM FLAP GATE

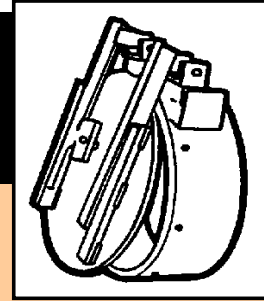

SIZE	FLATBACK		SPIGOTBACK		T-304-SS ANCHOR BOLTS[1]
	WT. (lbs.)	PRICE	WT. (lbs.)	PRICE	
12"	43	1864.00 07712510	25	1809.00 07712010	100.00
14"	50	1917.00 07714510	32	1859.00 07714010	100.00
15"	55	1951.00 07715510	35	1892.00 07715010	100.00
16"	58	2006.00 07716510	37	1945.00 07716010	100.00
18"	65	2226.00 07718510	40	2159.00 07718010	100.00
20"	69	2476.00 07720510	42	2401.00 07720010	151.00
21"	72	2690.00 07721510	44	2610.00 07721010	151.00
24"	80	2991.00 07724510	47	2901.00 07724010	151.00
27"	75	3581.00 07727510	50	3473.00 07727010	151.00
30"	92	3846.00 07730510	64	3730.00 07730010	164.00
36"	126	5012.00 07736510	96	4861.00 07736010	164.00
42"	Call for quote for current market pricing				
48"	Call for quote for current market pricing				
54"	Call for quote for current market pricing				
60"	Call for quote for current market pricing				
72"	Call for quote for current market pricing				
84"	Call for quote for current market pricing				

Note: Machined Flangeback available with 25lb or 125lb ANSI drilling POA

[1] Anchor Bolt Price per Set, Waterman Standard drilling.

Specify Corrugated Metal, Concrete, PVC type or HDPE when ordering with adapter. Inside diameter of pipe is required when ordering

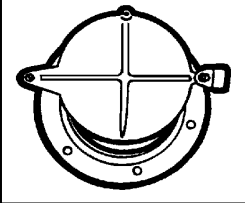
**Waterman****MODEL C-7 SHEAR GATE  
(LIGHT DUTY)**

SIZE	WT. (lbs.)	W / IRON COVER
4"	14	Call 16604001
6"	16	294.00 16606001
8"	16	336.00 16608001

SIZE	FRAME	BRONZE COVER	IRON COVER	LIFT LUG W / NUT & BOLT
4"	Call 40004166	Call 41004167	Call 41004166	Call 60800168
6"	184.00 71112080001	310.00 71115690003	132.00 71115690001	9.00 60800168
6" X 8"	Call 40007166	Call 41006167	Call 41006166	Call 60800168
8"	195.00 71112070001	342.00 71115680003	208.00 71115680001	9.00 60800168

Note: Call Factory for 4" C7 valve / parts availbilty and price.

Note: Call Factory for 6"x8" C7 parts availbilty and price.

**MISCELLANEOUS ITEMS**

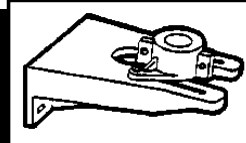
**STEM GUIDES**

TYPE	FOR STEM (DIA.)	WT. (lbs.)	PRICE	ADD FOR S.S. ANCHOR BOLTS
EYE BOLTS	7/8" TO 2	1/2"	59.00	-----
SK-1	7/8" TO 1 1/2"	3	74.00	-----
Galvanized				
SK-2	2" TO 3"	4	108.00	-----
Cast Iron				
K-2 (includes bronze bushings)				
(2" - 91/2" REACH)	7/8" TO 2"	28	475.00	65.00

**SQUARE STOCK FOR HANDLE**
**ROUND BAR STOCK HANDLE**

SIZE	WT. PER FOOT	PRICE PER FOOT	SIZE	WT. PER FOOT	COLD FINISH PRICE PER FOOT
5/8"	2	8.00 90058010	7/8"	2	9.00 181000006
3/4 "	2	10.00 90034010	1"	3	10.00 181000024
7/8"	3	11.00 90078010	1 1/8 "	3.3	13.00 181300003

**SQUARE HANDLE CONNECTORS**
**SQUARE RUBBER PACKING**

SIZE	PRICE EACH	SIZE	PRICE PER FOOT
5/8" SQUARE	26.00 55500060	1/4"	4.00 43400025
3/4 "SQUARE	27.00 55500075	5/16 "	4.00 43400026
5/8" SQUARE TO ROUND	20.00	3/8"	5.00 43400027
7/8" SQUARE	29.00 55500080	7/16 "	4.00
7/8" SQUARE TO ROUND	23.00	1/2"	5.00
		3/8" X 3/4 "	8.00

Note: Pricing on all square or round stock is carbon steel.



## MERCHANDISE

STANDARD DRAW BANDS			OVER SIZED DRAW BANDS	
O.D. SIZE (IN.)	ITEM #	PRICE (EA)	ITEM #	PRICE (EA)
4"	90000300	8.00	900003001	8.00
6"	90000310	8.00	900003101	8.00
8"	90000320	8.00	900003201	8.00
10"	90000330	8.00	900003301	8.00
12"	90000340	8.00	900003401	8.00
14"	90000345	8.00	900003451	8.00
15"	90000350	8.00	900003501	8.00
16"	90000360	10.00	NA	
18"	90000370	10.00	NA	

## NOTES:



P.O. BOX 458  
Exeter, California 93221, U.S.A  
Phone (559)562-4000 · Fax (559)562-2277  
**NATIONAL TOLL FREE (800) 331-0808**  
[www.watermanusa.com](http://www.watermanusa.com)

**DIVISION OFFICE**  
1701 N. Nashville Ave.  
Lubbock, Texas 79415  
Phone (806)763-5943 · Fax (806)763-8167